



Basic information on the prosthetic procedures



The ITI (International Team for Implantology) is academic partner of Institut Straumann AG in the areas of research and education.

CONTENT

1.	Straumann® Bone Level Implant – Straumann expertise applied at bone level	3
2.	General information	4
2.1	CrossFit® Connection	4
2.2	Prosthetic options	6
2.3	Abutment Overview	8
2.4	Coding	10
3.	Preoperative planning	12
3.1	Wax-up/Setup	12
3.2	X-ray template with reference spheres	12
3.3	Custom-made drill template	13
4.	Soft tissue management	14
4.1	Soft tissue management solutions	14
4.2	Prefabricated healing abutment	15
4.3	Overview consistent emergence profiles™	18
4.4	Customizable Healing Abutment	21
4.5	Temporary Abutment regular CrossFit® (RC) – Polymer with titanium-alloy inlay	23
4.6	Temporary abutment – Titanium alloy (TAN)	30
5.	Impression taking	33
5.1	Options for impression taking	33
5.2	Open-tray impression	34
5.3	Closed-tray impression	38
5.4	Bite registration	42
6.	Restoration	44
6.1	CrossFit® Plan SET/Plan abutment	44
6.2	Anatomic (and meso) Abutment	47
6.3	Gold Abutment for crown	54
6.4	Gold abutment for bridge	66
6.5	Straumann® Anatomic IPS e.max® Abutment	76
6.7	Cementable abutment	97
6.8	Straumann® Screw-retained Abutments	112
6.9	Abutment for bars	136
6.10	LOCATOR® Abutment	146
7.	Aids and instruments	162
7.1	SCS Screwdriver	162
7.2	Polishing Aid	162
7.3	Ratchet and Torque Control Device	163
7.4	Assembling the Ratchet and the Torque Control Device	165
7.5	Tightening an abutment to 35 Ncm	167
8.	About sterilization	169
9.	Important guidelines	170

PURPOSE OF THIS GUIDE

This guide describes the essential steps required for the fabrication and insertion of prosthetic restorations for Straumann® Bone Level Implants.

For detailed information regarding implantation and soft tissue management, please refer to *the Basic information on the surgical procedures – Straumann® Dental Implant System, 152.754*, or the *DVD Surgical and prosthetic procedures with the Straumann® Bone Level Implant, 150.760*.

Note

Procedures that apply for technicians in the dental lab are marked green.
Procedures that apply for prosthodontists are marked grey:

- Lab procedure
- Prosthetic procedure

Not all products shown are available in all markets.
All products shown in this guide are for single use only if not indicated otherwise.

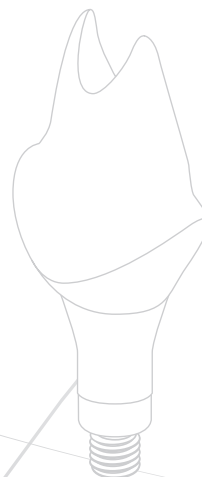
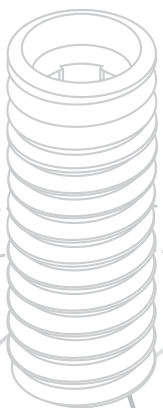

1. STRAUMANN® BONE LEVEL IMPLANT – STRAUMANN EXPERTISE APPLIED AT BONE LEVEL

The Straumann® Bone Level Implant provides you with a solution for all bone level treatments – Straumann expertise and quality built in. Its design is based on the latest technology and scientific know-how in implant dentistry. Moreover, it respects key biological principles, brings predictable esthetic results and offers simple handling in all indications.



Bone Control Design™

Optimize crestal bone preservation by adhering to biological principles

Consistent Emergence Profiles™

Experience simplified soft tissue management from start to finish

CrossFit® connection

Feel the fit of the self-guiding connection

Bone Control Design™

The unique Bone Control Design™ is based on key biological principles and thorough scientific research to support crestal bone preservation and stable soft tissue margins. It features the following strengths:

- Fast osseointegration with the SLActive® surface technology
- Optimal transmission of forces into the bone through the biomechanical implant design
- Consideration of the biological distance with a horizontal distance of micro gap to bone
- Reduction of micro movements while controlling the micro gap through a conical connection

Consistent Emergence Profiles™

The prosthetic components of the Straumann® Bone Level Implant line are designed to facilitate highly esthetic restorations that perfectly mimic natural teeth. These implant line components, designed to match the abutment profiles, allow you to easily attain esthetic results through soft tissue management.

CrossFit® connection

The prosthetic connection is intuitive, self-guiding and easy to grasp. The CrossFit® connection

- provides a clear-cut insertion through the guidance by 4 grooves and the deep, conical connection.
- ensures precision against rotation through orthogonal fit between implant and abutment.
- gives prosthetic flexibility with mechanical long-term stability through its conical connection.

2. GENERAL INFORMATION

2.1 CROSSFIT® CONNECTION

The Straumann® Bone Level Implant features an intuitive implant-abutment connection that is self-guiding and enables simple positioning. It allows clear-cut insertion with all components and provides outstanding protection against rotation as well as long-term stability.

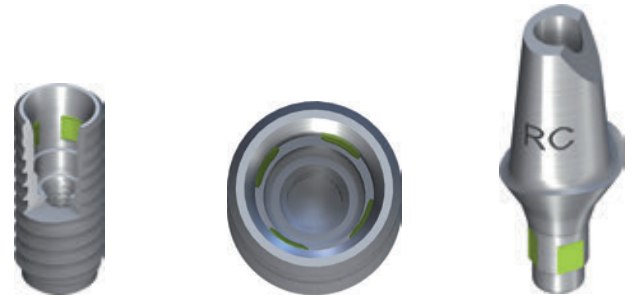

Precision and simplicity: 4 grooves

The CrossFit® connection features 4 grooves for the repositioning of prosthetic components.

This configuration is characterized by:

- simple implant alignment
- clear-cut and guided component insertion
- flexibility in the placement of angled prosthetic components
- optimal protection against rotation ensured by orthogonal implant-abutment fit



Internal connection viewed from above, showing the 4 internal grooves.

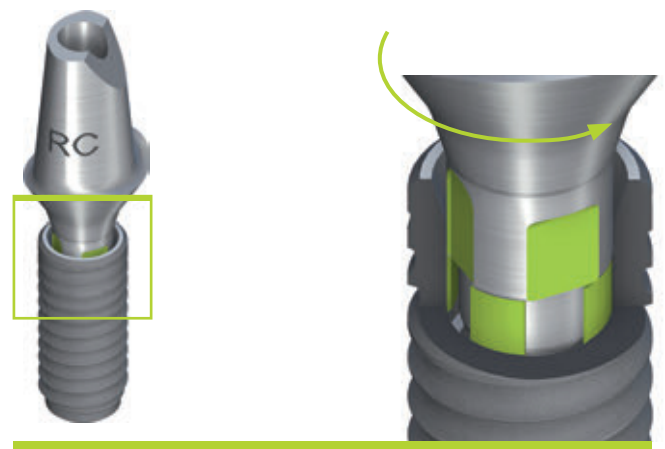

Abutment insertion, step 1.

The abutment is placed on the 4 grooves in the implant.



Abutment insertion, step 2.

The abutment is turned in until it is aligned with the 4 implant grooves.

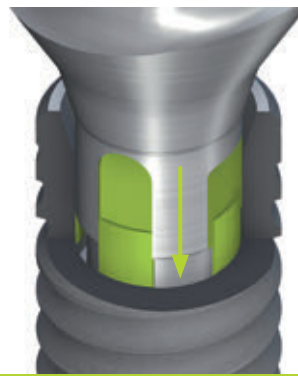

Abutment insertion, step 3.

The abutment then falls into the final position.



Abutment in place, showing the precise orthogonal fit between implant and abutment.

Reliability and flexibility: Conical connection

The CrossFit® connection features a cone with improved mechanical properties, providing more flexibility for prosthetic treatments.

The conical prosthetic connection provides:

- reduced micro movements and minimized microgap
- outstanding mechanical long-term stability and optimized stress distribution
- exact implant-abutment fit
- simplified impression taking even with divergently positioned implants

2.2 PROSTHETIC OPTIONS

Single crown



Screw-retained



Gold Abutment, for crown



Straumann® Anatomic
IPS e.max® Abutment



Straumann® CARES®
Ceramic Abutment



Straumann® Variobase®
Abutment



Straumann® Screw-retained
Abutment



Anatomic Abutment



Meso Abutment



Gold Abutment, for crown



Straumann® Anatomic
IPS e.max® Abutment



Straumann® CARES®
Ceramic Abutment



Straumann® Variobase®
Abutment



Straumann® CARES®
Titanium Abutment



Cementable Abutment

Bridge



Screw-retained



Gold Abutment, for bridge



Straumann® Screw-retained
Abutment



Anatomic Abutment



Meso Abutment



Gold Abutment, for crown



Straumann® Anatomic
IPS e.max® Abutment



Straumann® CARES®
Ceramic Abutment



Straumann® CARES®
Titanium Abutment



Straumann® Variobase®
Abutment





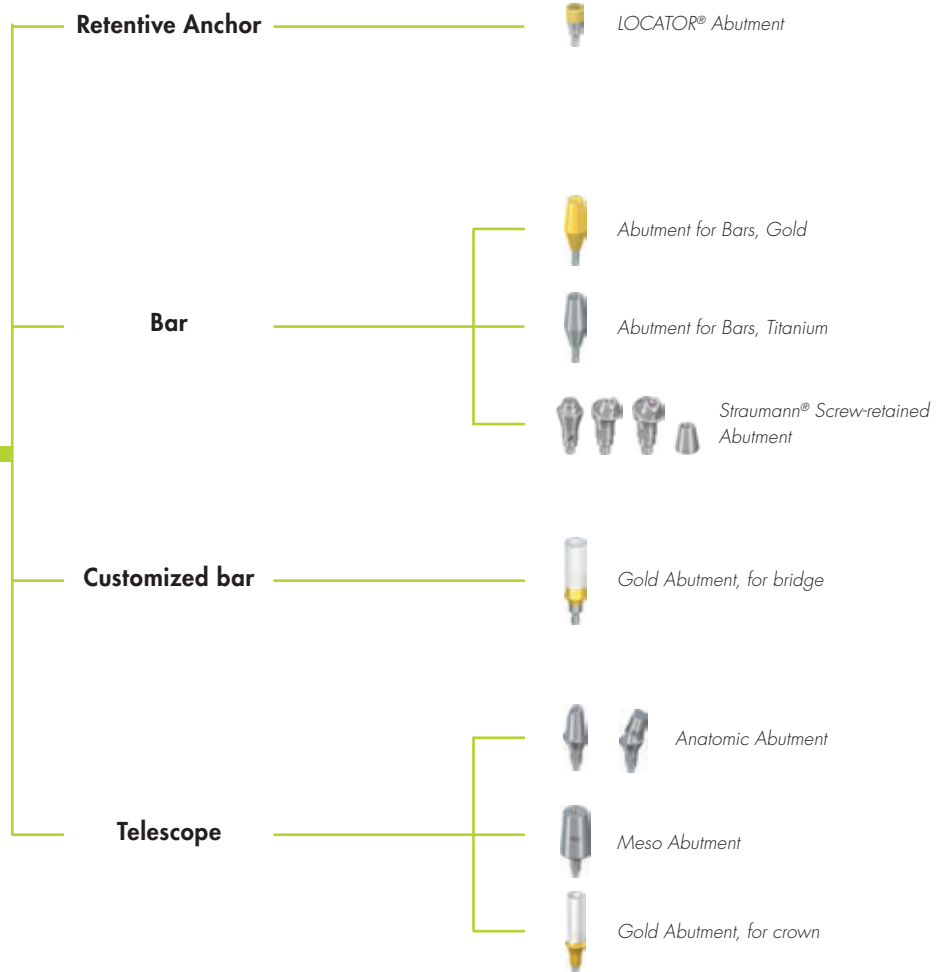

Cementable Abutment









Removable over-dentures



2.3 ABUTMENT OVERVIEW

	Anatomic Abutment	Meso Abutment	Gold Abutment, for crown	Gold Abutment, for bridge	Straumann® Anatomic IPS e.max® Abutment	
						
Single crown						
Screw-retained			●		●	
Cement-retained	●	●	●		●	
Bridge						
Screw-retained				●		
Cement-retained	●	●	●		●	
Removable overdentures						
Telescope	●	●	●			
Retentive anchor						
Bar				●		
Impression						
Implant level	●	●	●	●	●	
Abutment level						
Material*	Titanium	Titanium	Ceramicor®	Ceramicor®	Zirconium dioxide	
Chapter	6.2	6.2	6.3	6.4	6.5	

*See information on sterilization conditions in chapter 8.

Straumann® CARES® Ceramic Abutment	Straumann® CARES® Titanium Abutment	Straumann® Variobase® Abutment	Cementable Abutment	Straumann® Screw-retained Abutment	Abutment for Bars, Gold	Abutment for Bars, Titanium	LOCATOR® Abutment
							
●		●		●			
●	●	●	●				
				●			
●	●	●	●				
							●
				●	●	●	
●	●	●	●	●	●	●	●
			●	●			●
Zirconium dioxide	Titanium	Titanium alloy	Titanium	Titanium alloy	Ceramicor®	Titanium	Titanium alloy
1)	1)	2)	6.7	6.8	6.9	6.9	6.10







1) For further information regarding CARES® implant-borne prosthetics, please see the *Basic information on the Straumann® CARES® implant-borne prosthetic procedures*, 152.822/en.













2) For further information regarding Variobase®, please refer to the brochure *Basic information on Straumann® Variobase®*, 490.062/en.

2.4 CODING

The Straumann® Bone Level Implant line has a simple and consistent color coding and laser markings for quick and precise identification of secondary parts, surgical instruments and auxiliaries. This concept simplifies the communication substantially between the individuals involved in the treatment process.

The following scheme illustrates the above mentioned color codings and laser markings:

Connection	Implant Ø	Instruments	Implant	Closure screw
Narrow CrossFit® (NC)	3.3 mm			
Regular CrossFit® (RC)	4.1 mm 4.8 mm			
Laser marked (NC/RC)		●		●
Color-coded				●

Healing abutment	Impression post	Implant analog	Temporary abutment, VITA CAD-Temp®	Abutment
				
				
●				●
●	●	●	●  Screw head	●  Screw head

3. PREOPERATIVE PLANNING

Careful treatment planning is of utmost importance. Comprehensive pre-implantation diagnosis, evaluation and planning are prerequisites to ensure treatment success. The implant forms the apical extension of the restoration and is thus the planning basis for the surgical procedure aiming at a specific prosthetic result. Clear communication between the patient, dentist and dental technician is imperative to achieve excellent implant-borne restorations.

3.1 WAX-UP/SET-UP

To determine the topographical situation, axial orientation and the appropriate implants, making a wax-up/set up using the previously prepared study cast is recommended. Subsequently, the type of superstructure can be defined.

The wax-up/set-up can later be used as the basis for a custom-made X-ray or drill template and for a temporary restoration.

Abutments should always be loaded axially. Ideally, the long axis of the implant is aligned with the cusps of the opposing tooth. Extreme cusp formation should be avoided as this can lead to unphysiological loading.

3.2 X-RAY TEMPLATE WITH REFERENCE SPHERES

For easier determination of bone availability, the use of an X-ray template with X-ray reference spheres is recommended.

First, mark the selected implant positions on the study cast. Then fix the X-ray reference spheres at the marked points and make the vacuum-formed template with the spheres.

The subsequently taken X-ray or computer tomography (CT) gives information on bone availability, quality and mucosal thickness. Based on these properties the number of implants, the exact implant positions, diameters and lengths can be determined.

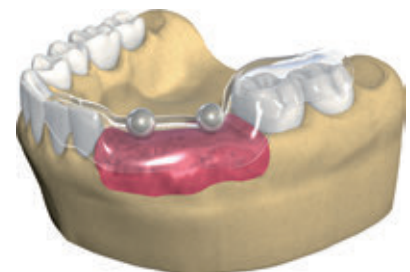





The X-ray reference sphere has a diameter of 5 mm. The image of the sphere on the X-ray provides the reference value for the magnification scale.

3.3 CUSTOM-MADE DRILL TEMPLATE

A custom-made drill template can facilitate planning and the preparation of the implant bed and enables precise use of the cutting instruments. The basis of planning when making this surgical template should be the desired prosthetic result.

With these components, a surgical drill template can be produced in the usual manner:

Art. No.	Article	Dimensions
049.810V4		Drill sleeve with collar height 10 mm outside Ø 3.5 mm inside Ø 2.3 mm
049.818V4		Stepped pin for 049.810 height 16 mm Ø 2.2/3.5 mm
049.816V4		Pin for 049.810 height 16 mm, Ø 2.2 mm
049.817V4		Pin for 049.810 height 10 mm, Ø 2.2 mm
049.819V4		Pin for 049.810 height 16 mm, Ø 3.5 mm

For step-by-step instructions, please refer to the brochure Fabrication and Use of an Individual Drill Template – Straumann® Drill Template, 152.290.

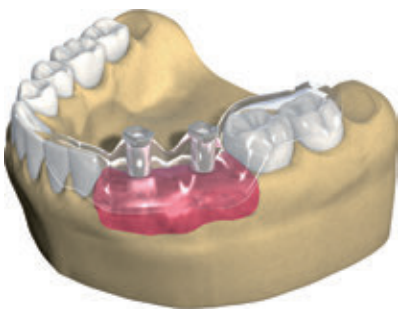

Vacuum-formed template with integrated drill sleeve as drilling template.

4. SOFT TISSUE MANAGEMENT

The Straumann® Bone Level Implant line puts a strong emphasis on esthetic considerations. It offers tailor-made solutions that allow for natural soft tissue shaping and maintenance in all indications. A versatile portfolio of healing and temporary abutments is available, including customizable products made of polymer for easy and fast processing.

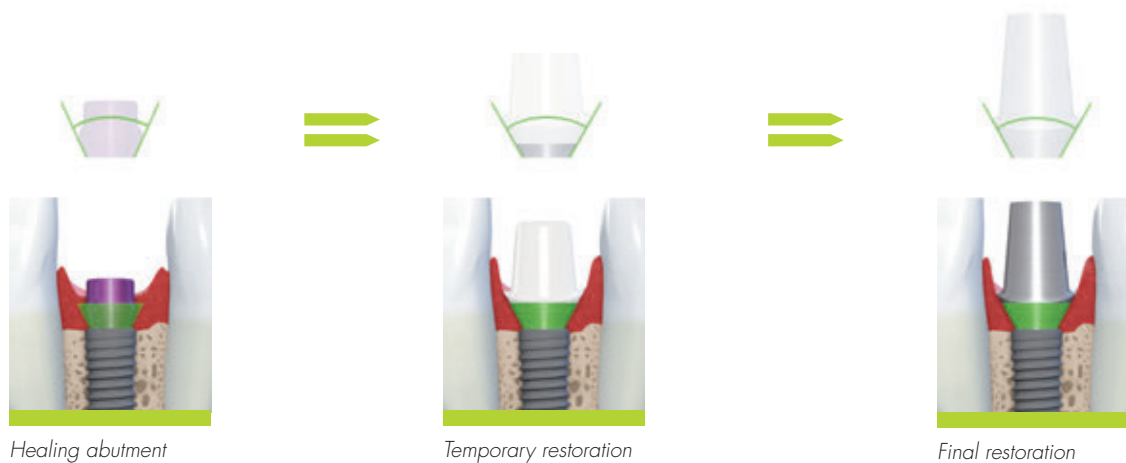

Esthetic results are determined by successful soft tissue management. To optimize the soft tissue management process, various components with Consistent Emergence Profiles™ are available in the prosthetic portfolio of the Straumann® Bone Level Implant. This applies for all healing abutments, the temporary abutment and the abutments for the final restoration. Thus, the emergence profiles are uniform throughout the treatment process (for optimal healing abutment selection see *chapter 4.3*).

4.1 SOFT TISSUE MANAGEMENT SOLUTIONS

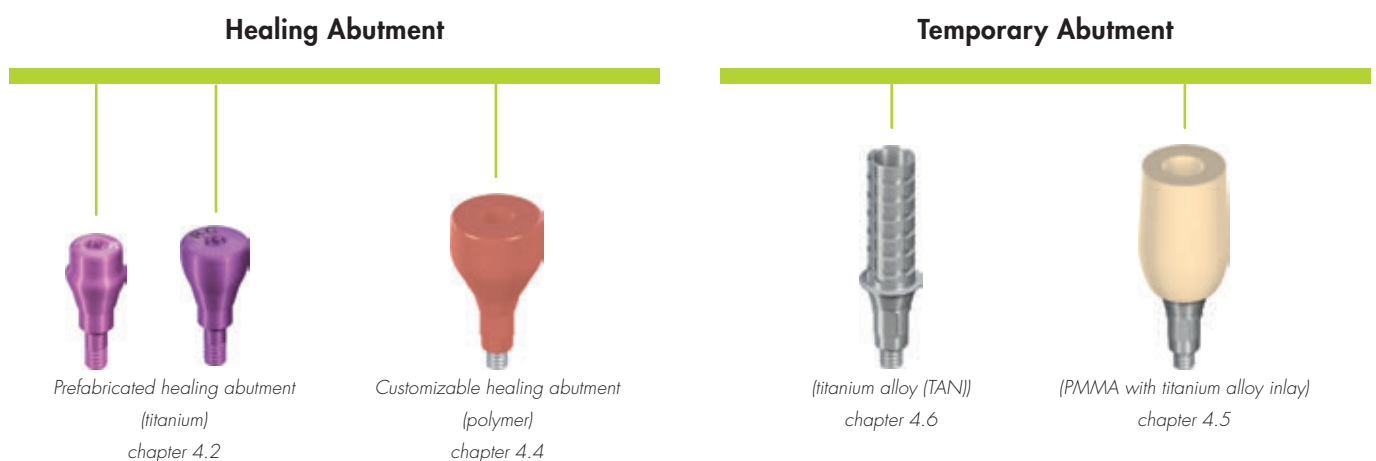

4.2 PREFABRICATED HEALING ABUTMENT

Intended use

- Soft tissue management
- Closure of implant connection for submerged and non-submerged healing

Characteristics

Simple

- One-piece design
- Color-coded and laser-marked
- Anatomically shaped emergence profiles, matching impression post and final abutments (for optimal healing abutment selection see *chapter 4.3*)

Reliable

- Tight connection



- Prosthetic procedure: pages 16–17

4.2.1 Prefabricated Healing Abutment – Prosthetic procedure

1

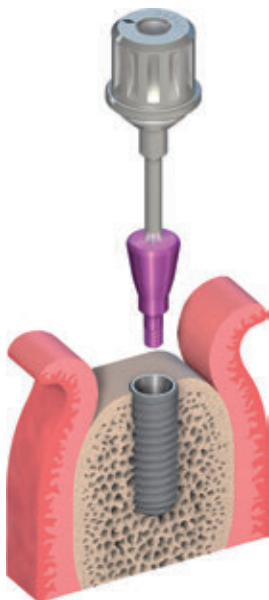

Step 1 – Insertion

- Insert the healing abutment with the SCS screwdriver. The friction fit secures the healing abutment to the instrument during insertion and ensures safe handling.
- Hand-tighten the healing abutment. The cone-in-cone design provides a tight connection between the two components.

2

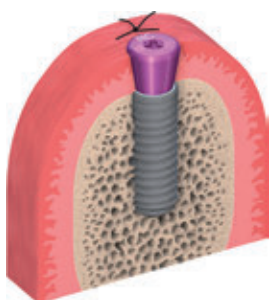

Step 2 – Wound closure

- Adapt the soft tissue and suture it back tightly around the abutment.

Optional: Bottle-shaped and Customizable Healing Abutment

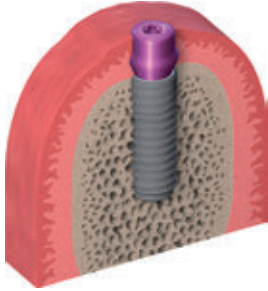

The bottle-shaped healing abutment pre-shapes the soft tissue by allowing for a slight excess of mucosa during healing. The insertion of the final restoration pushes the formed tissue outward, supports the creation of a naturally shaped peri-implant soft tissue.

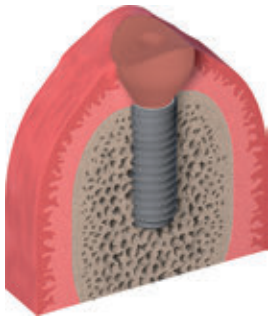

The customizable healing abutment allows for individual soft tissue management.

Note





Do not use the customizable healing abutment for longer than 6 months.









Healing abutments are delivered non-sterile and can be sterilized prior to use (for instructions see *chapter 8*).

4.3 OVERVIEW CONSISTENT EMERGENCE PROFILES™





Which healing abutments suit which abutments?





Cement-retained solutions

Platform	NC																	
Type	Anatomic Abutment						Cementable Abutment											
																		
Material	Ti		Ti		IPS e.max®		IPS e.max®		Ti			Ti						
Angle	0°		15°		0°		15°		0°			0°						
Ø (mm)	4.0		4.0		4.0		4.0		3.5			5.0						
GH (mm)	2.0	3.5	2.0	3.5	2.0	3.5	2.0	3.5	1.0	2.0	3.0	1.0	2.0	3.0				
GH (mm)	3.5	5.0	3.5	5.0	3.5	5.0	3.5	5.0	3.5	3.5	5.0	2.0	3.5	5.0				
Ø (mm)	4.8						4.8						4.8					
Type																		
	Conical healing Abutment																	

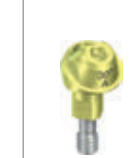







Platform	RC																	
Type	Anatomic Abutment						Cementable Abutment											
																		
Material	Ti		Ti		IPS e.max®		IPS e.max®		Ti			Ti						
Angle	0°		15°		0°		15°		0°			0°						
Ø (mm)	6.5		6.5		6.5		6.5		5.0			6.5						
GH (mm)	2.0	3.5	2.0	3.5	2.0	3.5	2.0	3.5	1.0	2.0	3.0	1.0	2.0	3.0				
GH (mm)	4.0	6.0	4.0	6.0	4.0	6.0	4.0	6.0	2.0	4.0	6.0	2.0	4.0	6.0				
Ø (mm)	6.5						6.5						5.0					
Type																		
	Conical Healing Abutment																	







Screw-retained solutions

Platform	NC															
Type	Anatomic Abutment				Screw-retained Abutment											
Material	IPS e.max®		IPS e.max®		TAN			TAN			TAN		TAN			
Angle	0°		15°		0°			0°			17°		30°			
Ø (mm)	4.0		4.0		3.5			4.6			4.6		4.6			
GH (mm)	2.0	3.5	2.0	3.5	1.0	2.5	4.0	1.0	2.5	4.0	2.5	4.0	5.5	2.5	4.0	5.5
	3.5	5.0	3.5	5.0	2.0	3.5	5.0	2.0	3.5	5.0	3.5			4.8		
Ø (mm)	4.8				3.6			4.8			4.8					
Type																
	Conical Healing Abutment															

Platform	RC															
Type	Anatomic Abutment				Screw-retained Abutment											
Material	IPS e.max®		IPS e.max®		TAN			TAN			TAN					
Angle	0°		15°		0°			17°			30°					
Ø (mm)	6.5		6.5		4.6			4.6			4.6					
GH (mm)	2.0	3.5	2.0	3.5	1.0	2.5	4.0	2.5	4.0	5.5	2.5	4.0	5.5			
	4.0	6.0	4.0	6.0	2.0	4.0	6.0	4.0			5.0					
Ø (mm)	6.5				5.0			5.0								
Type																
	Conical Healing Abutment															

Hybrid solutions

Platform	NC																
Type	Screw-retained Abutment									LOCATOR®							
Material	TAN			TAN			TAN			TAN			Ti alloy				
Angle	0°			0°			17°			30°			0°				
Ø (mm)	3.5			4.6			4.6			4.6			3.8				
GH (mm)	1.0	2.5	4.0	1.0	2.5	4.0	2.5	4.0	5.5	2.5	4.0	5.5	2.0	3.0	4.0	5.0	6.0
GH (mm)	2.0	3.5	5.0	2.0	3.5	5.0	3.5			3.5			2.0	3.5	5.0		
Ø (mm)	3.6			4.8			4.8			4.8			3.6				
Type																	
Type																	
	Conical Healing Abutment																

Platform	RC														
Type	Screw-retained Abutment									LOCATOR®					
Material	TAN			TAN			TAN			Ti alloy					
Angle	0°			17°			30°			0°					
Ø (mm)	4.6			4.6			4.6			3.8					
GH (mm)	1.0	2.5	4.0	2.5	4.0	5.5	2.5	4.0	5.5	1.0	2.0	3.0	4.0	5.0	6.0
GH (mm)	2.0	4.0	4.0	3.5			3.5			2.0	4.0	6.0			
Ø (mm)	5.0			5.0			5.0			5.0					
Type															
Type															
	Conical Healing Abutment														

4.4 CUSTOMIZABLE HEALING ABUTMENT

Intended use

- Individual soft tissue management for esthetic cases
- Closure of implant connection during healing phase

Characteristics

Simple

- Polymer material allows for easy and quick chair-side modification
- Easy-to-achieve esthetics due to gingiva-colored and modifiable polymer material

Reliable

- CrossFit® connection

Note

Do not use for longer than 6 months.

The customizable healing abutment can be shortened vertically no more than 5 mm.



- Prosthetic procedure: page 22

4.4.1 Customizable Healing Abutment – Prosthetic procedure



Step 1 – Customizing

- Individualize the healing abutment on an analog according to the mouth situation. Heatless wheels and new cross-toothed millers are recommended for grinding.



- To avoid smearing of the polymer, adjust the bur speed properly (low rpm frequency, little pressure).

Step 2 – Insertion

- Hand-tighten the healing abutment in the implant with the SCS screwdriver and temporarily seal the screw channel (e.g. with composite).

4.5 TEMPORARY ABUTMENT REGULAR CrossFit® (RC) – POLYMER WITH TITANIUM-ALLOY INLAY



Intended use

- Individual soft tissue management for esthetic cases
- Screw- or cement-retained temporary crowns
- Cement-retained temporary bridges

Characteristics

Simple

- Polymer material allows for easy and quick chair-side modification
- Easy-to-achieve esthetics due to tooth-colored and modifiable polymer material

Reliable

- Precise fit and high stability due to reinforcement with titanium-alloy inlay
- CrossFit® connection

Note

Do not use for longer than 6 months. Place temporary restoration out of occlusion.

- The devices are provided non-sterile and are for single use only.
- The abutment must be secured against aspiration. The abutments can be processed with cleaning/disinfecting agents such as Ethanol, Tego Cid 2%, Micro 10 + 4%, Cidex OPA pure and Grotanat 2%.
- The abutment can be steam-sterilized (121°C / 250°F for 20 minutes).

4.5.1 Prosthetic procedure for Temporary Abutment RC

Modification of abutments – How far to reduce the dimensions

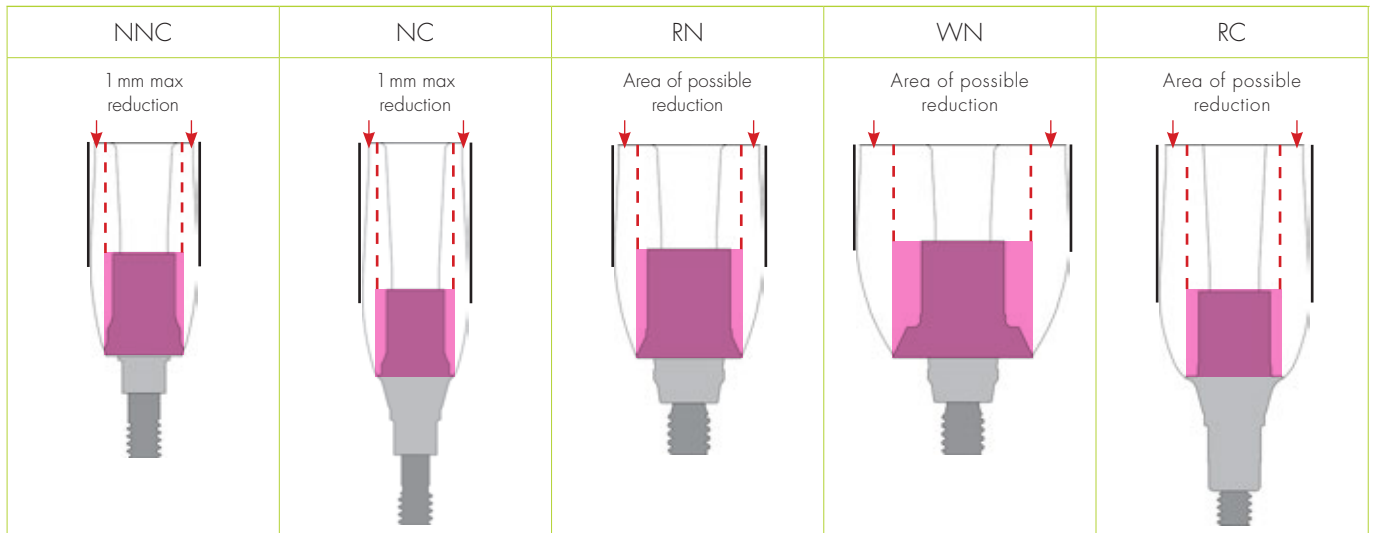

Red line indicates the area of maximum reduction

Note

Please refer to the graphics above for details on modification limits.

The temporary abutment height can be shortened with standard tools and techniques, but should not be reduced beyond the metal core. The **width must not be reduced** by more than 1 mm at the thickest part (NNC, NC) or further than the metal margin (RN, WN, RC).



Option A: Screw-retained temporary crown

Step 1 – Individualization – Removing material

Individualize the temporary abutment on an analog according to the mouth situation. Fine-cut tungsten-carbide tools are recommended for processing this polymer material.

Insertion in master model

Hand-tighten the temporary abutment in the implant/implant analog with the SCS screwdriver and temporarily seal the screw channel (e.g. with cotton).



Step 2 – Option A: Fabricating the temporary restoration – Direct veneering

Directly add the veneering material in order to fabricate the temporary restoration.

Step 2 – Option B: Fabricating the temporary restoration – Vacuum stents

Create the temporary restoration according to standard techniques (e.g. vacuum stents).

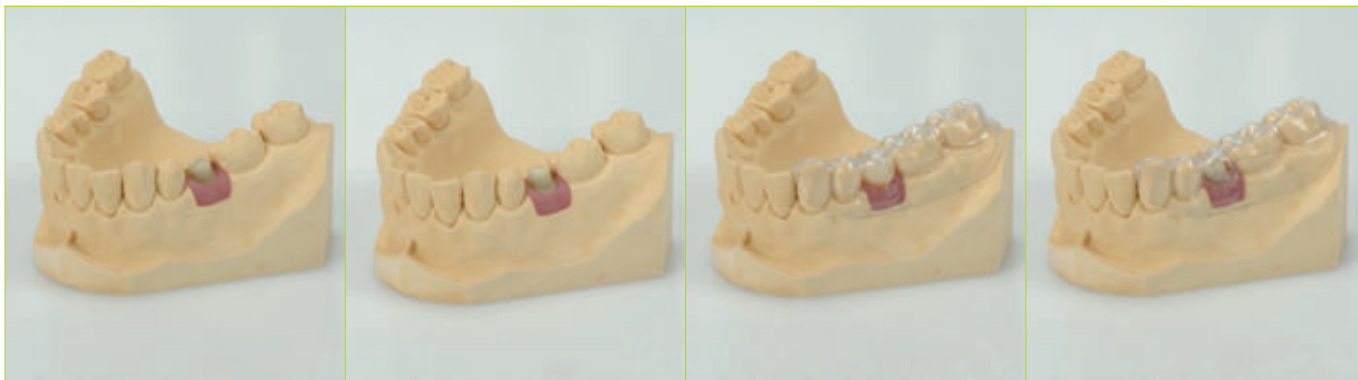

Note

Before adding up any material or performing corrections with veneering material (i.e. VITA VM[®] LC materials, refer to the manufacturer's instructions), the surface of the temporary restorations must be cleaned and wetted with modeling liquid.

Note

Clean the abutment with a steam jet.



Step 3 – Finishing

Remove excess acrylic, reopen the screw channel and finish the temporary restoration.

Note

Restorations made from VITA CAD-Temp® can be pre-polished with a suitable silicone polisher and a small goat-hair brush. Standard acrylic polishing agents that are also suitable for intraoral use are used for high luster polishing.

Avoid creating excessive heat.

Important:

Careful polishing is absolutely necessary to achieve a perfect result and to avoid plaque accumulation and related negative effects on the shade.

Use a polishing aid or implant analog to protect the implant configuration while polishing the temporary restoration.



Step 4 – Final insertion

Clean and sterilize the polished temporary restoration (refer to the manufacturer's instructions of the veneering material).

Place the temporary restoration on the implant and tighten the screw between 15 Ncm and 35 Ncm (depending on implant stability) using the SCS screwdriver along with the ratchet and the torque control device.



Option B: Cement-retained temporary crown

Step 1 – Individualization – Removing material

Individualize the temporary abutment on an analog according to the mouth situation. Fine-cut tungsten-carbide tools are recommended for processing this polymer material.

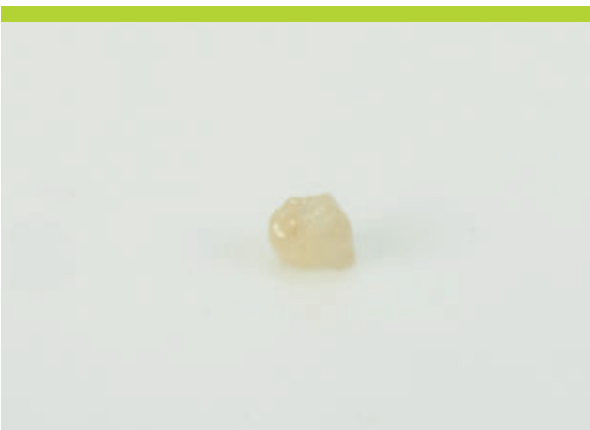

Step 2 – Fabricating the cement-retained temporary single crown

Use a standard procedure to fabricate the cement-retained single crown (e.g. grind out a prefabricated plastic tooth).





Step 3 – Final insertion

Clean and sterilize the polished temporary abutment.

Place the customized temporary abutment on the implant and tighten the screw between 15 Ncm and 35 Ncm (depending on implant stability) using the SCS screwdriver along with the ratchet and the torque control device.



Cover the screw head with absorbent cotton or gutta-percha and seal the screw channel temporarily (e.g. with absorbent cotton).



Step 4 – Cementing the temporary single crown

Coat the internal configuration of the crown with temporary cement and cement it on the temporary abutment.

4.6 TEMPORARY ABUTMENT – TITANIUM ALLOY (TAN)

Intended use

- Engaging abutments are used for
 - Screw- or cement-retained temporary crowns
 - Cement-retained temporary bridges
- Non-engaging abutments are used for
 - Screw-retained temporary bridges

Characteristics

More solutions

- Narrow diameter for narrow interdental spaces
- Crowns and bridges
- Screw- and cement-retained
- Anterior and posterior region

Reliable

- Precise fit and high stability due to titanium alloy (TAN) material
- CrossFit® connection for engaging abutments



Note

Do not use for longer than 180 days.

Place temporary restorations out of occlusion.

The temporary abutment can be shortened vertically no more than 6 mm with standard tools and procedures.

The devices are provided non-sterile and are for single use only.

The abutment must be secured against aspiration.

Refer to the veneer material manufacturer for information regarding the disinfectants that can be used.

The abutments can be processed with cleaning/disinfecting agents such as Ethanol, Tego Cid 2 %, Micro 10 + 4 %, Cidex OPA pure and Grotanat 2 %.

The abutment can be steam-sterilized (134 °C/ 273 °F for 5 min).

- Lab procedure: pages 31–32
- Prosthetic procedure: pages 31–32

4.6.1 Temporary Abutment – Procedure for a screw-retained bridge temporary restoration

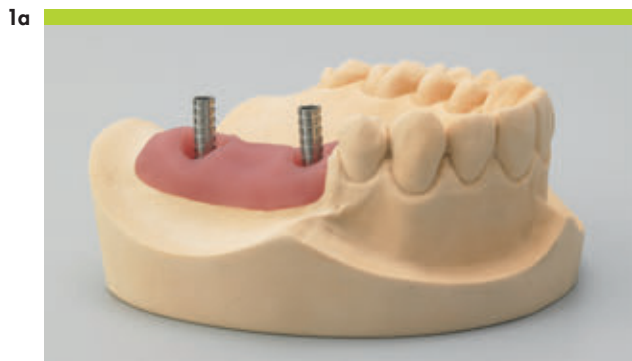

Step 1 – Preparation

- Mount the temporary abutment on the master cast or in patient's mouth.
- Mark the appropriate heights according to the individual situation.
- Remove the abutment from the patient's mouth.



- Shorten the abutment as necessary using standard technique.
- The upper section of the abutment should be sandblasted before opaquing.
- Coat the temporary abutment with opaquer to prevent the titanium alloy (TAN) from showing through.



- Screw the copings onto the implant in the patient's mouth and temporarily seal the screw channels (e.g. with cotton).

Note

Repeat the procedure for screw- or cement-retained crown provisional restoration by using the engaging temporary abutments. Use the SCS screwdriver 046.401 (short) or 046.402 (long). Depending on implant stability, tighten with a torque between 15 Ncm and 35 Ncm. Hand-tighten on the master cast. The abutment should not diverge more than 30° for a screw-retained bridge. Manufacture a meso structure with a cemented restoration in order to compensate divergences greater than 30°.

- Lab procedure
- Prosthetic procedure



Step 2 – Creating the provisional

- Use standard procedure to fabricate the provisional (e.g. prefabricated crown or bridge form or vacuum-formed sheet technique as shown here). The retention elements ensure proper mechanical bonding of the veneering material to the temporary abutment.
- Remove excess acrylic, reopen the screw channel and finish the temporary restoration.

Step 3 – Inserting the provisional

- Clean and disinfect the polished temporary restoration, place it on the implants and tighten the screw between 15 Ncm and 35 Ncm (depending on implant stability) using the SCS screwdriver along with the ratchet and the torque control device (for instructions see chapter 7.5).
- Cover the screw head with absorbent cotton or gutta-percha and seal the screw channel with temporary veneering material (e.g. composite).

5. IMPRESSION TAKING

5.1 OPTIONS FOR IMPRESSION TAKING

Impressions for the Straumann® Bone Level Implant can be taken by either of the two following procedures:

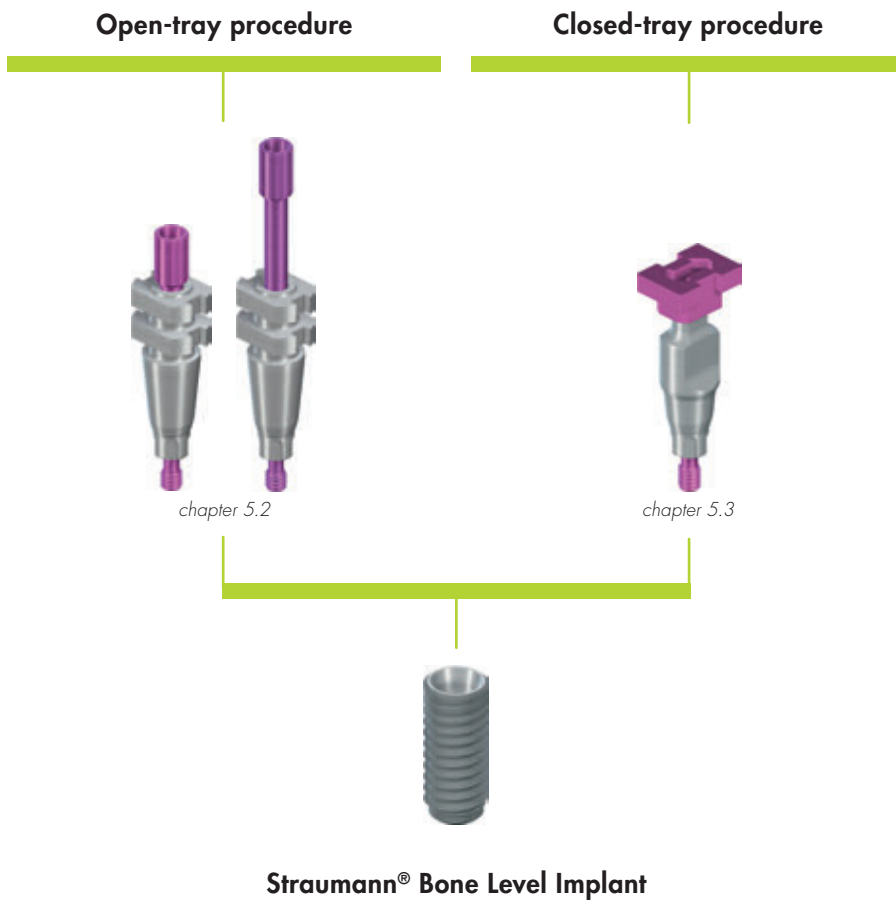

The procedure used depends on the user's preference and the clinical situation. Both procedures are described in the following chapters.

5.2 OPEN-TRAY IMPRESSION

Intended use

- Open-tray impression procedure

Characteristics

Simple

- Color-coded components corresponding to prosthetic connection
- Slender emergence profile accommodates space limitations
- Guide screw can be tightened either by hand or with the SCS screwdriver

Reliable

- High-precision impression components give an exact replica of the intraoral situation
- Clear-cut tactile response from the prosthetic connection verifies proper seating of components

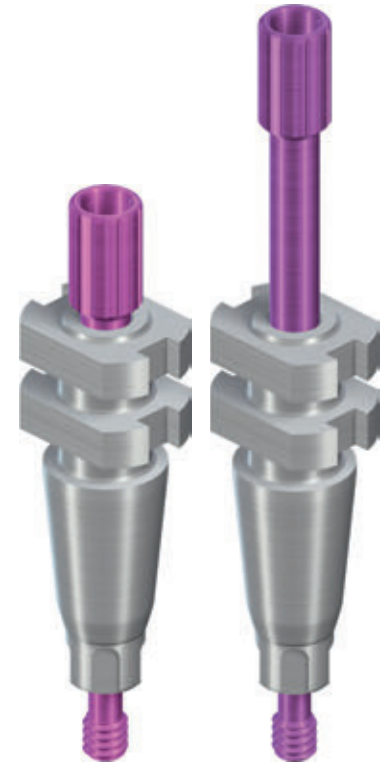

Note

Open-tray impression procedure requires a custom-made tray with perforations. Impression posts are intended **for single use only** to ensure optimal fit and precise impression taking for each patient.

- Prosthetic procedure: pages 35–36
- Lab procedure: page 37

5.2.1 Open-tray impression – Prosthetic procedure

1



Step 1 – Positioning the impression post

- Ensure sufficient access to the implant site in order to avoid pinching in the gingival tissue. Be aware that the sulcus may collapse rapidly once the healing components have been removed.
- Clean the internal configuration of the implant thoroughly from blood, tissue, etc. prior to the impression procedure.
- Place the impression post accurately into the implant and hand-tighten the guide screw.
- In case of occlusal space limitation, the length of the impression post can be reduced by one retention ring after the guide screw has been removed.

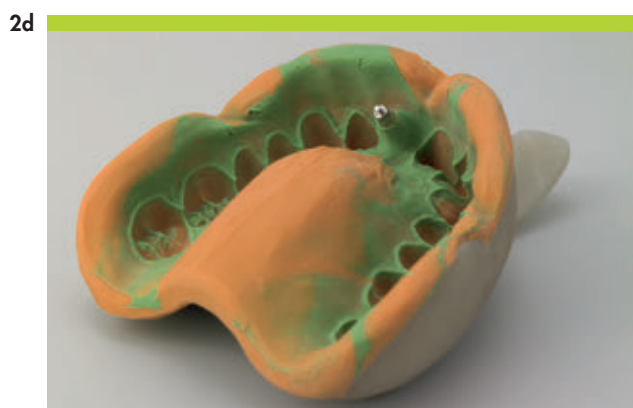

Step 2 – Impression taking

- Make perforations in the custom-made impression tray (light cured resin) according to the individual situation so that the positioning screw of the impression post sticks out.

- Take the impression using an elastomeric impression material (polyvinyl siloxane or polyether rubber).

Note

Due to its low tensile strength, hydrocolloid is not suitable for this application.

- Uncover the screws before the material is cured.
- Once the material is cured, loosen the guide screws and remove the tray.

5.2.2 Open-tray impression – Lab procedure

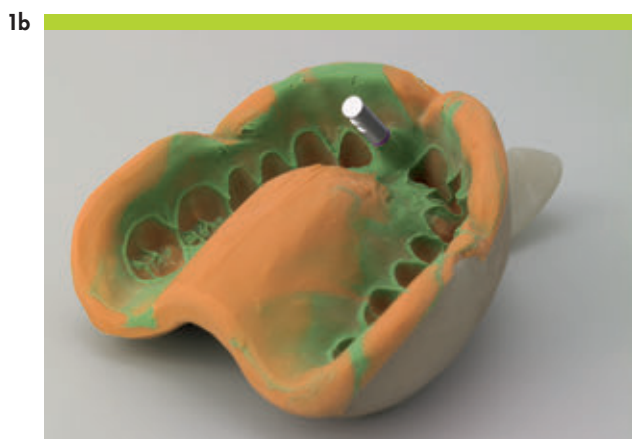
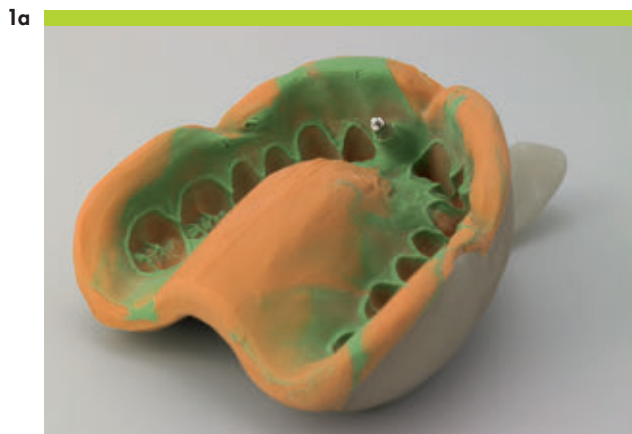

Step 1 – Analog repositioning and fixing

- Reposition and fix the analog in the impression using the guide screw. To avoid inaccuracies when connecting, the analog must be positioned exactly in line with the grooves of the impression post before screwing in.

Note

When tightening the screw, grasp the retentive section of the analog securely to prevent the impression post from rotating. This is especially important with a shortened post.

Step 2 – Fabricating the master cast

- Fabricate the master cast using standard procedure and type-4 dental stone (DIN 6873). A gingival mask should always be used to ensure that the emergence profile of the crown is optimally contoured.

5.3 CLOSED-TRAY IMPRESSION

Intended use

- Closed-tray impression procedure

Characteristics

Simple

- Color-coded components corresponding to prosthetic connection
- Slender emergence profile to accommodate space limitations
- No additional preparation (i.e. perforation) of tray required

Reliable

- High-precision impression components give an exact replica of the intraoral situation
- Clear-cut tactile response from the prosthetic connection verifies proper seating of components

Note

Impression posts are intended **for single use only** to ensure optimal fit and precise impression taking for each patient.

A spare cap is provided with each package in case there is a need to retake the impression immediately.



- Prosthetic procedure: pages 39–40 and 42–43
- Lab procedure: page 41

5.3.1 Closed-tray impression – Prosthetic procedure

1a



Step 1 – Positioning the impression post

- Ensure sufficient access to the implant site in order to avoid pinching in the gingival tissue. Be aware that the sulcus may collapse rapidly once the healing components have been removed.
- Clean the internal configuration of the implant thoroughly from blood, tissue, etc. prior to the impression procedure.
- Place the impression post accurately into the implant and tighten the guide screw hand-tight (using the SCS screwdriver).

Note

Ensure that the lateral planar areas of the post are facing mesial and distal.

1b



- Place the polymer impression cap on top of the fixed impression post. Ensure that the color of the cap corresponds to the color of the positioning screw in the post and that the arrows are aligned with the oral-vestibular direction.
- Push the impression cap in apical direction until it clicks. The impression cap is now firmly seated on the impression post.



Step 2 – Impression taking

- Take the impression using an elastomeric impression material (polyvinyl siloxane or polyether rubber).

Note

Due to its low tensile strength, hydrocolloid is not suitable for this application.



- Once the material is cured, carefully remove the tray. The impression cap remains in the impression material and therefore is automatically pulled off from the impression post with the removal of the tray.



- Unscrew and remove the impression post and send it together with the impression tray to the dental technician.

5.3.2 Closed-tray impression – Lab procedure



Step 1 – Analog fixing and impression post repositioning

- Mount the impression post on the analog using the guide screw. To avoid inaccuracies when connecting, the analog must be positioned exactly in line with the grooves of the impression post before screwing it in.

Note

Ensure that the color code of the guide screw corresponds to the color code of the analog and that the color code of the analog corresponds to the color code of the polymer cap in the impression material.

- Reposition the impression post in the tray.
- Smoothly push the impression post until you feel the tactile response of engagement. It is now firmly seated on the impression cap in the impression tray.

Step 2 – Fabricating the master cast

- Fabricate the master cast using standard procedure and a type-4 dental stone (DIN 6873). A gingiva mask should always be used to ensure that the emergence profile of the crown is optimally contoured.

5.4 BITE REGISTRATION

To simplify bite registration after impression taking, plastic bite registration aids are available in various heights. For repositioning on the master cast, the bite registration aids have a flat side laterally.

1



Step 1 – Insertion

- Insert the bite registration aids into the implants. Each component is fitted with a snap mechanism that holds it in the internal configuration.

Note

Protect the components against aspiration (e.g. use a throat pack or a thread).

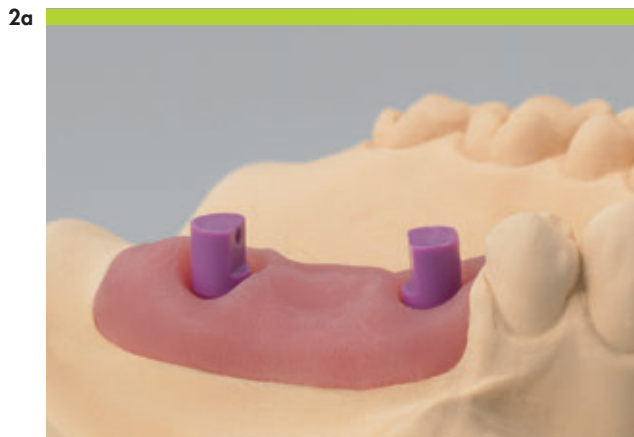

Step 2 – Shortening

- Shorten the bite registration aids (if needed) and apply the bite registration material. To ensure the repositioning from the mouth to the master cast, the occlusal area and the lateral flat side of the bite registration aids must be adequately surrounded with the registration material.

Note

Bite registration aids must be shaped out of the mouth. If they need to be shortened occlusally due to lack of space, ensure that the lateral flat side is not ground off.



Step 3 – Positioning

- To transfer the bite, put the bite registration in the analogs on the master cast. Fix the bite wax model and mount the maxilla and mandible casts on the articulator.

6. RESTORATION

6.1 CROSSFIT® PLAN SET/PLAN ABUTMENT

Intended use

- Intra- and extra-oral planning of prosthetic restoration

Characteristics

Simple

- Color-coded, well-marked and easily readable Plan abutments
- Comprehensive Plan set containing all Plan abutments arranged clearly
- Easy handling with the SCS screwdriver

Reliable

- Proper seating of Plan abutments verified through the clear-cut response from the prosthetic connection
- Plan abutments fabricated of sterilizable polymer material

Note

After intraoral use clean and sterilize the Plan abutments with moist heat.

Do not sterilize the cassette or its components.

Replace non-functional Plan abutments.



- Lab procedure: page 45
- Prosthetic procedure: pages 45–46

6.1.2 CrossFit® Plan Set/Plan abutment selection

The Straumann® CrossFit® Plan Set allows for optimal planning of the restoration in the mouth and on the model. It gives the dentist and the dental technician greatest flexibility in cooperative planning and minimizes the quantity of stock abutments. The Plan set contains all Plan abutments available for the Straumann® Bone Level Implant (anatomic, cementable, screw-retained, gold, Variobase®, LOCATOR®).

1a



Step 1 – Selecting the right abutment

- Open the Plan set cassette, pick up a Plan abutment and secure it with the SCS screwdriver (empty mold for instruments built in).

1b



- Place the Plan abutment on the implant (intra-oral use) or implant analog (extra-oral use). This will aid in checking dimensions (rings on Plan abutments indicate gingiva height), axial alignment and screw axis of the potential restoration.

2



Step 2 – Ordering the stock abutment

- Once the best fitting Plan abutment is determined, order the corresponding stock abutment (titanium, gold) using the allocation chart on the Plan set inlay card.

6.1.3 Cleaning and sterilizing Plan abutments

- Clean the Plan abutments thoroughly with water or ethanol after intra-oral use.
- After cleaning, sterilize Plan abutments with moist heat (autoclave) for 18 minutes at 134 °C (273 °F).
- Refer to the manufacturer's specifications for the heat-sterilization device.

Note

Do not sterilize Plan abutments more than 20 times.

Do not gamma-sterilize Plan abutments.

Do not sterilize the cassette or its components.

6.2 ANATOMIC (AND MESO) ABUTMENT

Intended use

- Cement-retained restorations

Characteristics

Simple

- Less grinding necessary due to prepared mucosa margins
- Adaptation to natural soft tissue contour due to prepared mucosa margins in different heights
- Oval shape resembles emergence profile of a natural tooth

Reliable

- CrossFit® connection

Note

Not suitable for direct ceramic veneering.

A minimum height of 3 mm above the mucosa margin of the abutment must be maintained in order to maintain proper stability of the abutment.

The cement margin must not be more than 2 mm below the mucosa.

Use a new basal screw for the final insertion of the abutment.



- Lab procedure: pages 48–52
- Prosthetic procedure: page 53

6.2.1 Anatomic (and Meso) Abutment – Lab procedure

The following case describes the fabrication of a cement-retained single crown by using the anatomic abutment.



Step 1 – Fabricating the master cast and wax-up

- Fabricate the master cast including a gingiva mask with the corresponding implant analog (for instructions see chapter 5).

- For optimal esthetic planning, model a full anatomical wax-up.

- Make a silicone key over the full wax-up in order to define the optimal shape of the customized abutment.

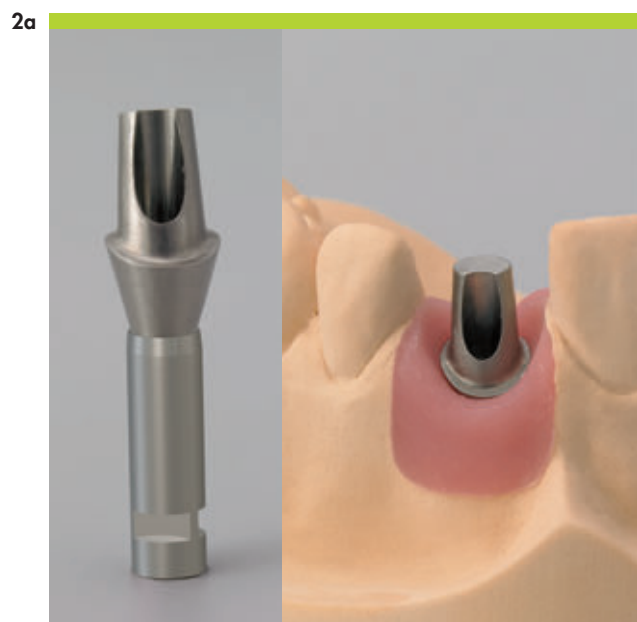

Step 2 – Preparing the Anatomic or Meso Abutment

- The anatomic abutment and the meso abutment (see following page) are made of titanium and can be modified as required.

Note

To maintain proper stability of the abutment, a minimum height of 3 mm above the mucosa margin of the abutment must be maintained.

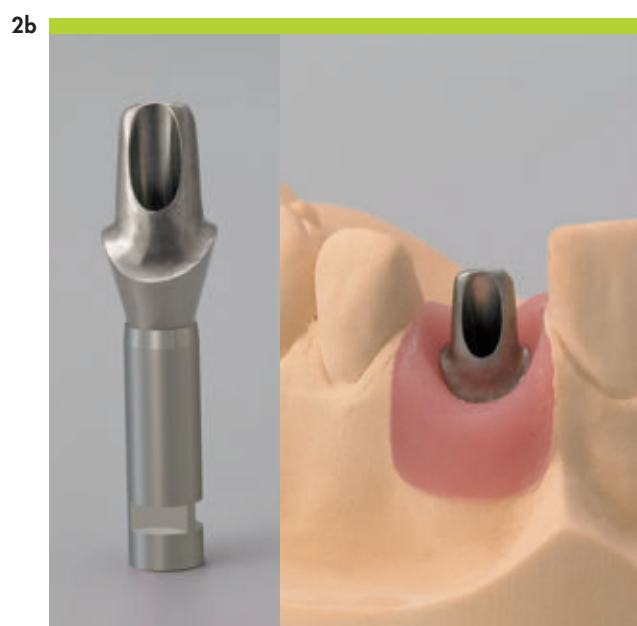

- The anatomic abutment after modification.

■ Lab procedure

If the anatomic abutment does not fit your individual demands or if you prefer grinding the mucosa margins yourself, you can use the meso abutment. The processing of the meso abutment corresponds to the processing of the anatomic abutment.



3

**Step 3 – Fabricating the superstructure**

Fabricate the superstructure on the modified abutment using the standard modelling, casting and veneering methods.

- Place the modified abutment on the polishing aid/analog and hand-tighten the screw using the SCS screwdriver.
- Wax an individual resin cap onto the abutment.
- Contour a wax model according to the anatomical circumstances of the individual cast.
- Check the wax-up with the silicone key.

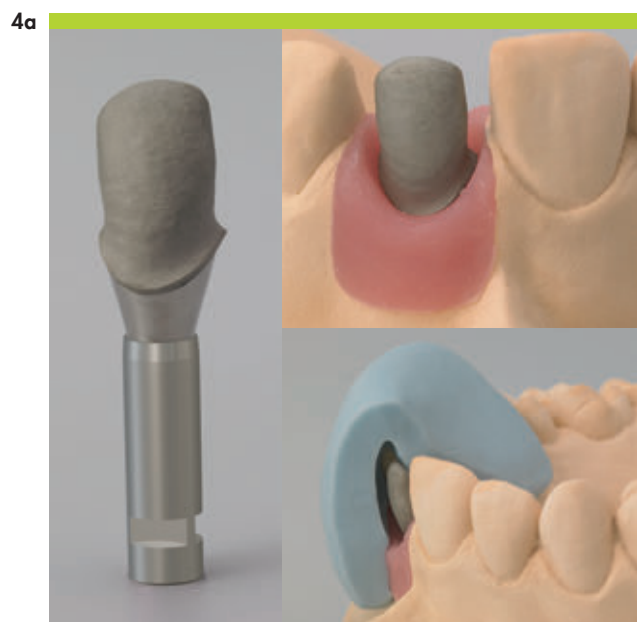

Step 4 – Casting and veneering

- Cast the framework using the standard procedure.

- Check the framework with the silicone key before veneering.

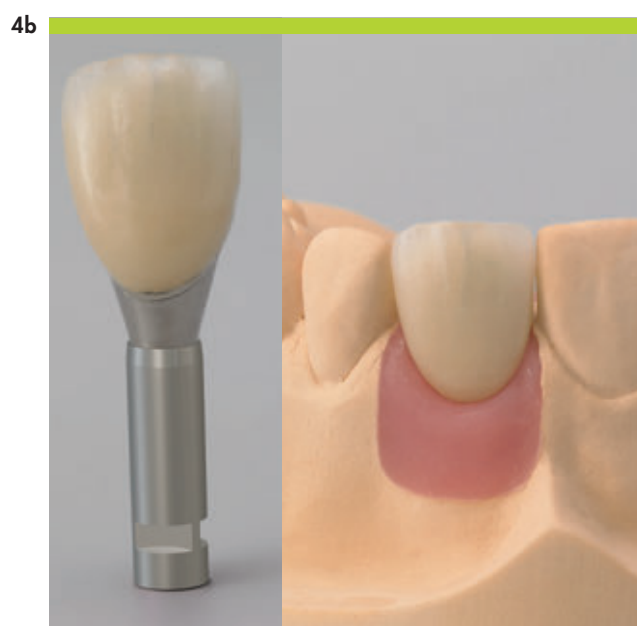

- Veneer the superstructure.

6.2.2 Anatomic Abutment – Prosthetic procedure

The final restoration is delivered to the doctor's office on the master cast.



Step 1 – Preparation

- Remove the healing cap or temporary restoration.
- Remove the superstructure from the master cast and unscrew the abutment from the analog.
- Clean and dry the interior of the implant and the abutment thoroughly.

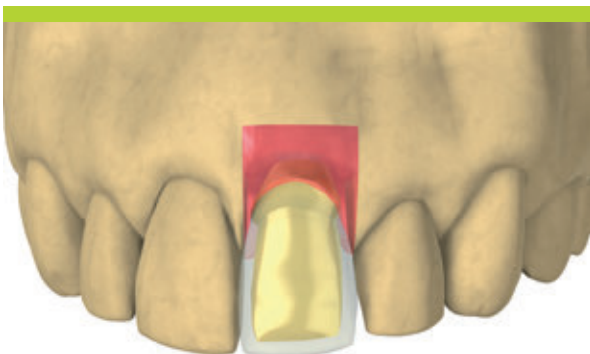

Step 2 – Final insertion

- Position the cleaned abutment in the implant. Tighten the screw to 35 Ncm using the SCS screwdriver along with the ratchet and the torque control device (for instructions see chapter 7.5).
- Close the SCS configuration of the screw with cotton and sealing compound (e.g. gutta-percha). This allows a later removal of the customized abutment in case a crown replacement is required.
- Cement the superstructure to the abutment.
- Remove superfluous cement.

6.3 GOLD ABUTMENT FOR CROWN

Intended use

- Screw-retained or cement-retained crowns
- Cement-retained bridges via mesostructure (custom abutment technique)
- Telescopic crowns and telescopic bridges

Characteristics

Simple

- Easy wax-up and protection of the screw channel due to modelling aid (burn-out polymer)
- Easy-to-achieve esthetics due to individual contouring of the emergence profile and adaptation to the margin of the gingival contour

Reliable

- Superfluous cement easily removable by raising the cement margin using an individually designed mesostructure
- CrossFit® connection

Note

Not suitable for direct splinting with other gold abutments. For screw-retained bridges the gold abutment for bridge must be used (for instructions see chapter 6.4).

Use a new basal screw for the final insertion of the abutment.

Do not shorten the gold abutment for crown by more than 1.5 mm.



- Lab procedure: pages 55–64
- Prosthetic procedure: page 65

6.3.1 Gold Abutment for crown – Lab procedure

The following case describes the fabrication of a cement-retained single crown by utilizing the custom abutment technique.



Step 1 – Fabricating the master cast and wax-up

- Fabricate the master cast including a gingiva mask with the corresponding implant analog (for instructions see chapter 5).



- For optimal esthetic planning, model a full anatomical wax-up.



- Make a silicone key over the full wax-up in order to define the optimal shape of the customized abutment.



Step 2 – Preparing the Gold Abutment

- Place the gold abutment on the analog and hand-tighten the screw using the SCS screwdriver.

- Shorten the modelling aid to the height of the occlusal plane according to the individual circumstances. Working with the modelling aid ensures a clean and sharp-edged finish of the screw channel.



- Attach the gold abutment to the polishing aid for easier handling during manipulation outside of the model.

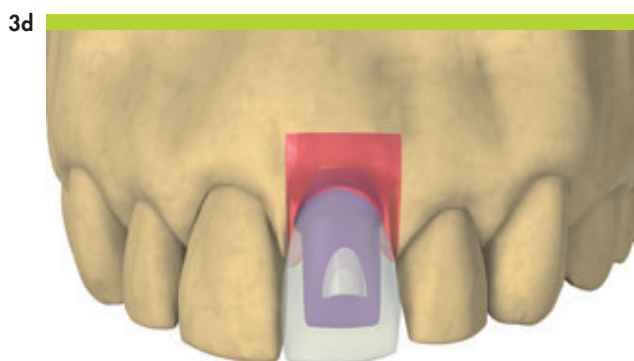
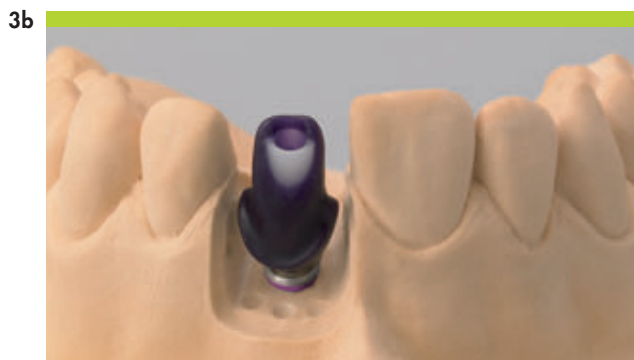

Step 3 – Wax modelling

- Contour a wax-up shape according to the individual anatomical situation. The silicone key shows the exact space for the cement-retained crown, which will be made over the customized abutment.

- Make sure that the wax layer on the abutment is sufficiently thick (at least 0.7 mm). Do not cover the delicate margin of the abutment with wax.

- Check the wax-up with the silicone key.

Note

The picture displays the optimal configuration of a customized abutment, showing an ideal emergence profile. This configuration ideally adapts the crown contours to the margin of the gingival contour. For reasons of hygiene, the cement margin must not lie any further than 2 mm below the gingival level.

4



Step 4 – Investment

- Invest the customized abutment according to standard procedure without using wetting agents.

Note

In order to avoid overflow of the cast-on alloy, thoroughly clean the abutment prior to investment (removal of wax particles, insulating agents with a cotton pellet or brush moistened with alcohol).

Always do the cast with the modelling aid. Otherwise, the dental casting alloy will not or only too thinly flow out at the upper coping rim.

Ensure that there is no wax on the delicate margin. The use of investment materials for rapid heating methods (speed investment materials) is not recommended.

When processing the investment material, follow the manufacturers' instructions. Observe the recommended mixing ratio and preheating time exactly.

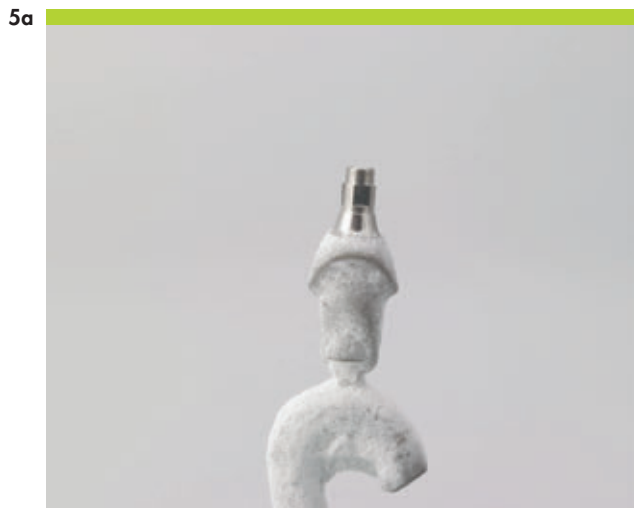

Step 5 – Casting and deinvestment

- Cast the customized abutment.
- Gently deinvest the customized abutment with ultrasound, water jet, pickling acid or a glass fiber brush.

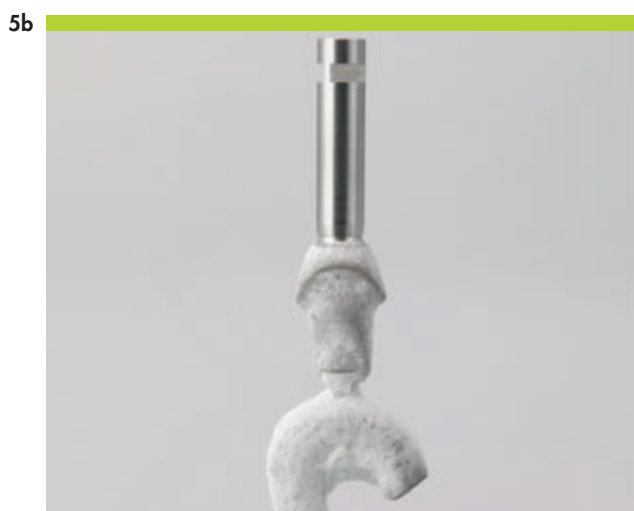

Note

For the deinvestment of the gold abutment with sandblasting (maximum pressure: 2 bars; maximum alumina particle size: 50 µm), the inner configuration has to be protected from infiltration with sand with the polishing aid.

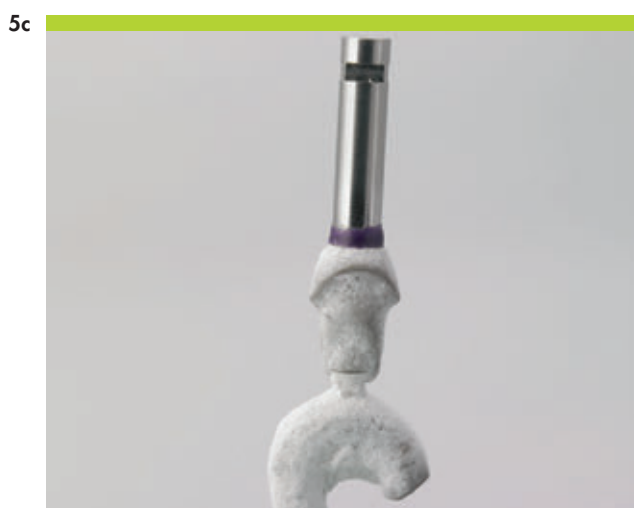

- The wax-fixed polishing aid allows better fixation and protects the pre-polished part of the gold abutment.

5d



- The gold abutment after sandblasting.

5e



Note

Do not sandblast the inner configuration of the gold abutment.



Step 6 – Polishing

- After trimming, polish the finished customized abutment.



- The customized abutment is now ready for the fabrication of the cement-retained single crown.



Step 7 – Fabricating the cement-retained single crown

- Block out the screw channel and wax the framework directly over the customized abutment.

- The silicone key shows the spatial relations for the restoration.

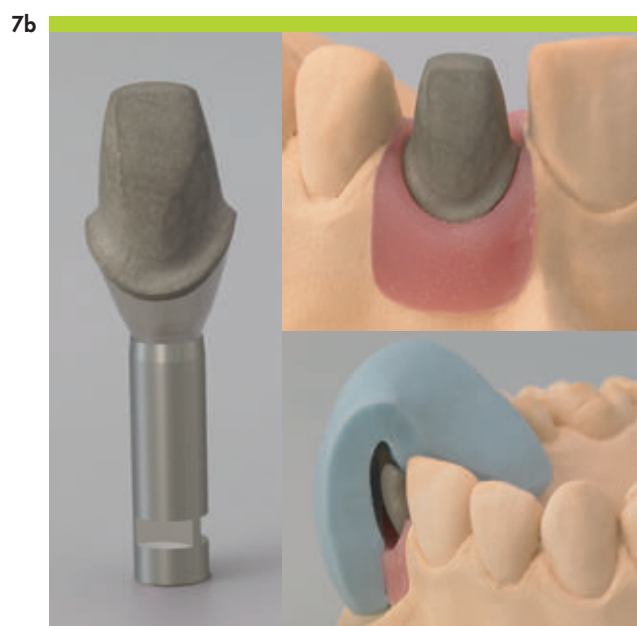

- Cast the framework in the conventional manner. After trimming the cast, the metal crown fits precisely on the customized abutment.

- The silicone key shows the spatial relations for veneering.



- Veneer the superstructure.

Casting errors and incorrect handling

*Ground down to
abutment level*



Note

The long-term success of the prosthetic work depends on the accurate fit of the restoration.

The entire procedure has to be repeated if...

- ...trimming through the cast-on alloy prohibits the Ceramicor® surface from being covered with ceramic veneering material (Ceramicor® is a non-oxidizing alloy and does not allow ceramic bonding).

Failed casting



- ...the cast-on gold did not flow out entirely.

Improper investment



- ...intruded casting metals and casting pearls cannot be removed from the connection part of the gold abutment.

Using alloys with castable Ceramicor® components

Ceramicor® is only suitable for cast-on procedures

Ceramics can not be bonded directly to cast-on Ceramicor® components as this alloy does not form bonding oxides.

When selecting the casting alloy, ensure that it is compatible with the high-fusing alloy of the Ceramicor® components. The melting range of the casting alloy must not exceed a liquidus temperature of 1350 °C/2462 °F.

Ceramicor® must not be cast on with base metal casting alloys, because gold in combination with nickel or cobalt destroys the components.

Suitable dental casting alloys

- High noble alloys
- Precious metal alloys with a minimum content of gold and platinum group metals of 25%
- Palladium-based alloys with a minimum content of palladium of 50%

ISO standard alloy types

Alloy types according to the following ISO standards are suitable for cast-on procedures to the prefabricated Ceramicor® component:

- ISO standard 9693
- ISO standard 22674

Note

The alloy manufacturer's recommendation must be followed. Due to diffusion at the alloy and the cast-on coping interface, components made from an unsuitable alloy may form phases with low-strength, reduced corrosion resistance or a lower melting range.

6.3.2 Gold Abutment for crown – Prosthetic procedure

The final restoration is delivered to the doctor's office on the master cast.



Step 1 – Preparation

- Remove the healing cap or temporary restoration.
- Remove the superstructure from the master cast and unscrew the abutment from the analog.
- Clean and dry the interior of the implant and the abutment thoroughly.

Step 2 – Final insertion

Option A: Screw-retained crown

- Position the cleaned abutment in the implant. Tighten the screw to 35 Ncm using the SCS screwdriver along with the ratchet and the torque control device (for instructions see chapter 7.5).
- Close the SCS configuration of the screw with cotton and sealing compound (e.g. gutta-percha or composite). This allows later removal of the customized abutment in case a crown replacement is required.

Option B: Cement-retained crown

- Position the cleaned abutment in the implant. Tighten the screw to 35 Ncm using the SCS screwdriver along with the ratchet and the torque control device (for instructions see chapter 7.5).
- Close the SCS configuration of the screw with cotton and sealing compound (e.g. gutta-percha or composite). This allows later removal of the customized abutment in case a crown replacement is required.
- Cement the crown to the mesostructure.
- Remove superfluous cement.

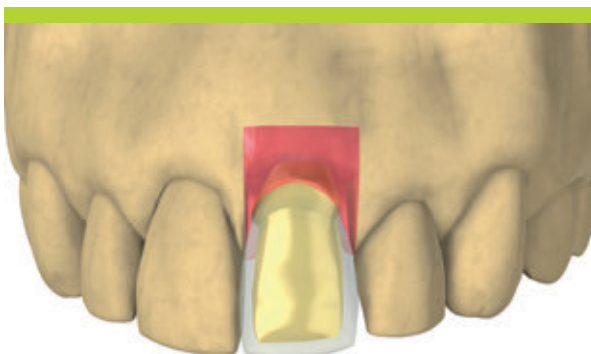

Note

The figure displays the optimal configuration of a customized abutment, showing an ideal emergence profile. This configuration ideally adapts the crown contours to the margin of the gingival contour. For reasons of hygiene, the cement margin must not lie any further than 2 mm below the gingival level.

6.4 GOLD ABUTMENT FOR BRIDGE

Intended use

- Screw-retained bridges
- Screw-retained customized bars

Characteristics

Simple

- Easy wax-up and protection of the screw channel due to modelling aid (burn-out polymer)
- Easy-to-achieve esthetics due to individual contouring of the emergence profile and adaptation to the margin of the gingival contour

Reliable

- No cement gap
- One-screw solution

Note

Not suitable for single crowns. Use the gold abutment for crown for single crowns (for instructions see chapter 6.3).

Use a new basal screw for the final insertion of the abutment.

Do not shorten the gold abutment for bridge by more than 2.5 mm.



- Lab procedure: pages 67–74
- Prosthetic procedure: page 75

6.4.1 Gold abutment for bridge – Lab procedure

The following case describes the planning of a screw-retained bridge.



Step 1 – Fabricating the master cast and wax-up

- Fabricate a master cast including a gingiva mask with the corresponding analogs (for instructions see chapter 5).



- For optimal esthetic planning, model a full anatomical wax-up.



- Make a silicone key over the full anatomical wax-up in order to define the optimal shape of the customized bridge.



Step 2 – Preparing the gold abutments

- Place the gold abutments for bridge on the analogs and hand-tighten the screws using the SCS screwdriver.

- Shorten the modelling aids to the height of the occlusal plane according to individual circumstances. Working with the modelling aid ensures a clean and sharp-edged finish of the screw channel.

- To avoid a deformation of the conical design of the connection it is highly recommended to always attach the gold abutment to the polishing aid while working outside of the model.

3a



Step 3 – Wax modelling

- Contour a wax-up shape according to the individual anatomical situation.
- Make sure that the wax layer on the abutment is sufficiently thick (at least 0.7 mm). Do not cover the delicate margin of the abutments with wax.

3b



- Check the spatial conditions before casting the bridge framework with the silicone key of the wax-up.

4



Step 4 – Investment

- Check that the wax framework of the bridge is absolutely tension-free before investing the framework. Use standard investing procedures for a tension-free framework.
- Invest the bridge framework according to standard methods without using wetting agents.

Note

In order to avoid overflow of the cast-on alloy, thoroughly clean the abutments prior to investment (removal of wax particles, insulating agents with a cotton pellet or brush moistened with alcohol).

Ensure that there is no wax on the delicate margin. The use of investment materials for rapid heating methods (speed investment materials) is not recommended.

When processing the investment material, follow the manufacturer's instructions. Strictly observe the recommended mixing ratio and preheating time.



Step 5 – Casting and devestment

- Cast the bridge framework.

Note

The long-term success of the prosthetic work depends on the accurate fit of the restoration. The entire procedure will have to be repeated, if casting errors occur, similar to the examples on page 63.



- Allow for enough cooling time of the casted bridge before the devestment.
- Gently deinvest the bridge framework with ultrasound, water jet, pickling acid or a glass fiber brush.

For the deinvestment of the gold abutments with sandblasting (maximum pressure: 2 bars; maximum alumina particle size: 50 µm), the inner configuration has to be protected from infiltration from sand with the polishing aid.



- The wax-fixed polishing aid allows better fixation and protects the pre-polished part of the gold abutments.

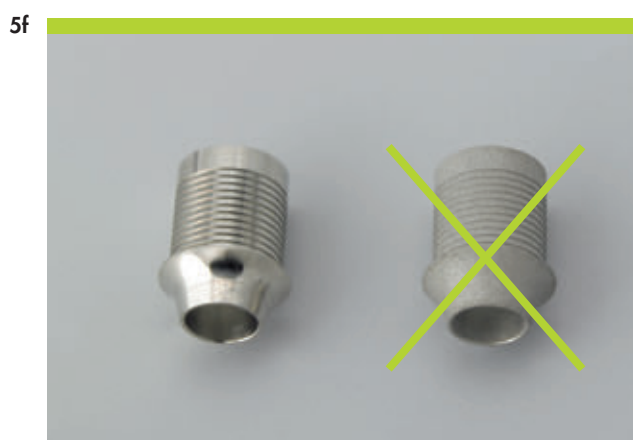

Note

To help ensure success of the restoration, a perfect prosthetic fit in the internal connection of the implant is mandatory. Take particular care not to let the bridge reconstruction fall down onto any surface. Due to the weight of the bridge construction, this might have a negative impact on the high-precision connection of the gold abutment. If the construction falls down at anytime, repeat the entire procedure.

- Do not sandblast the inner configuration of the gold abutment.



Step 6 – Preparation before veneering

- Remove the sprues and smooth the removal areas.
- Check the spatial conditions with the silicone key.



- Control tension-free fitting on the master cast (Sheffield test). If the bridge is not tension-free and therefore wiggles, cut the bridge and resplint it in a tension-free manner.

Note

In order to take the bridge off the master cast, all basal screws need to be removed first.





- Do an additional try-on of the tension-free fit of the framework in the mouth of the patient.



Step 7 – Veneering

- Veneer the superstructure.

6.4.2 Gold abutment for bridge – Prosthetic procedure

The final restoration is delivered to the doctor's office on the master cast.



Step 1 – Preparation

- Remove the healing abutment or temporary restoration.
- Remove the superstructure from the master cast and unscrew the bridge from the analogs.
- Clean and dry the interior of the implants and the bridgework thoroughly.
- Check the tension-free fit of the bridgework before tightening it in the mouth of the patient.

Note

Do not insert the bridge in case of movements due to tensions in the bridgework.

Step 2 – Final insertion

- Position the cleaned bridgework in the implants.
- Tighten the screws to 35 Ncm using the SCS screwdriver along with the ratchet and the torque control device (for instructions see chapter 7.5).
- Close the SCS configuration of the screws with cotton and sealing compound (e.g. gutta-percha or composite). This allows later removal of the bridge work if needed.

6.5 STRAUMANN® ANATOMIC IPS e.max® ABUTMENT

Intended use

- Cement-retained crowns and bridges via mesostructure
 - Conventional procedure
 - Temporary restoration chairside
- Screw-retained crowns
 - Direct veneering (with IPS e.max® Ceram)
 - Press-on technique (with IPS e.max® ZirPress)

Material

- Zirconium dioxide

Characteristics

Simple

- Processing of a highly esthetic ceramic abutment in different colors with conventional lab methods
- Less grinding necessary due to prepared mucosa margins
- Adaptation to natural soft tissue contour due to prepared mucosa margins in different heights
- Oval shape resembles emergence profile of a natural tooth

Reliable

- Biocompatible and low thermal conductivity
- High-performance all-ceramics thanks to a high strength and high fracture toughness
- Reduced risk of margins shining through the soft tissue even with thin mucosa biotype
- CrossFit® connection
- Precise fit

Note

Only use an original Straumann basal screw for ceramic abutment for the final insertion of the Straumann® Anatomic IPS e.max® Abutment. The Straumann® Anatomic IPS e.max® Abutment is available in the following shades: MO 0 and MO 1 (MO = Medium Opacity). Recommendations regarding the sterilization procedure can be found in the instructions for use.



- Lab procedure: pages 78–89
- Prosthetic procedure: pages 90–95

The following cases describe the fabrication of:

Option A: cement-retained crowns and bridges using the Straumann® Anatomic IPS e.max® Abutment;

Option B: screw-retained crowns directly veneered using the Straumann® Anatomic IPS e.max® Abutment and IPS e.max® Ceram;

Option C: screw-retained crowns using the Straumann® Anatomic IPS e.max® Abutment in combination with the press-on technique. In this case IPS e.max® ZirPress has been used.

Cement-retained restorations need to fulfill the following criteria (see graphic 2c on page 80):

- Individualized abutments must have cusp and marginal ridge support.
- The maximum thickness of the veneering material on top of the coping must not exceed a maximum of 2.0 mm in all directions.
- Avoid any sharp edges.

Screw-retained restorations need to fulfill the following criteria (see graphic 2c on page 80):

- In the anterior region, screw hole access must be located in the palatal/lingual area of the restoration.
- The screw hole position in the incisal or labial area is **contraindicated**.
- In the posterior area, screw hole position must be located in the center of the occlusal area of the restoration.
- Before veneering or press-on procedure, the individualized abutment must have a reduced, anatomically supporting design (cusp and marginal support).
- The maximum thickness of the veneering material on top of the individualized abutments (layering ceramic and/or press-on ceramic) must not exceed a maximum of 2.0 mm in all directions of the screw-retained restoration

6.5.1 Straumann® Anatomic IPS e.max® Abutment – Lab procedure

1a



Step 1 – Fabricating the master cast and wax-up

- Fabricate the master cast including a gingival mask with the corresponding implant analog (for instructions see chapter 5).

1b



- For optimal esthetic planning, design a full anatomical wax-up.

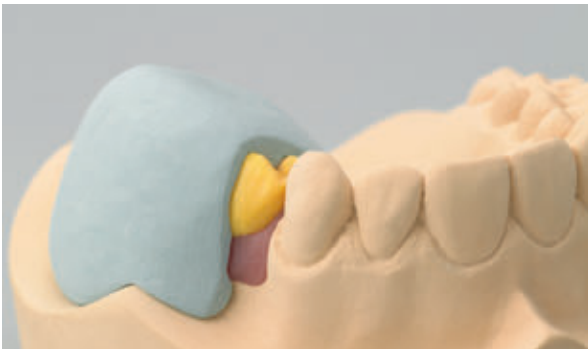

- Make a silicone key over the full wax-up in order to define the optimal shape of the modified abutment.



Step 2 – Preparing the Straumann® Anatomic IPS e.max® Abutment

- Place the abutment on the polishing aid / analog and hand tighten the screw using the SCS screwdriver.



- For the individualization of the Straumann® Anatomic IPS e.max® Abutment, it is recommended to work with a water-cooled turbine and abrasive instruments that are appropriate for grinding sintered ZrO_2 material. Work with a low grinding pressure and avoid any spark formation. The Ivoclar Vivadent grinding instrument recommendations for IPS e.max® must be followed.

2c

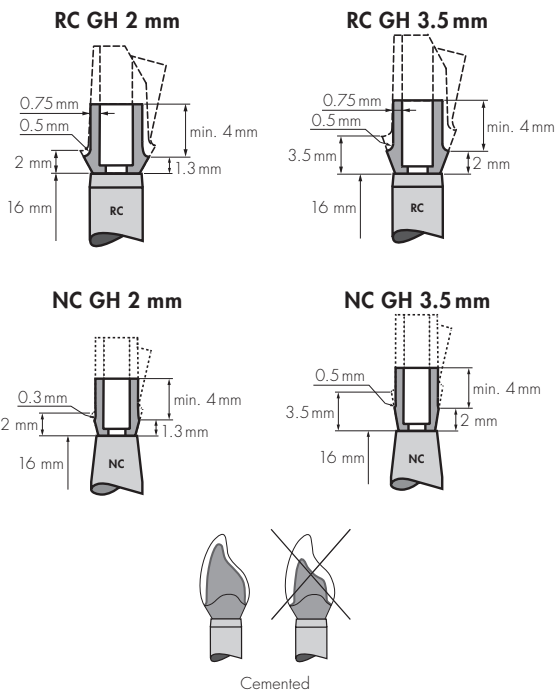

Note

In order to keep sufficient stability of the abutment, **do not deviate** from the dimensions shown in the following graphics (2c). The height of the abutment must achieve at least 65 % of the total restoration.

- The final geometry of the abutment has to meet the requirements of the material of the final restoration for cement-retained crowns and bridges.

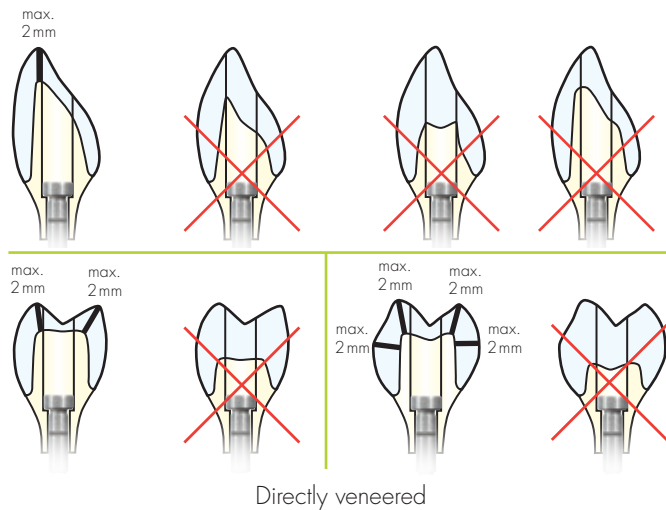

- The final geometry of the abutment has to meet the requirements of the veneering material for screw-retained crowns, directly veneered or using the press-on technique.

2d



- Following the Ivoclar Vivadent grinding instrument recommendations for IPS e.max®, a regeneration firing for cement-retained crowns and bridges is not required. The regeneration firing has to be conducted if the Ivoclar Vivadent grinding instrument recommendations for IPS e.max® are not followed or if a further thermal processing is necessary. The regeneration firing parameters are: 65 °C (117 °F) per minute heating up to 1050 °C (1922 °F) / 15 minute holding time and long-term cooling down with 25 °C (45 °F) per minute to 750 °C (1382 °F).

Option A – Cement-retained crowns and bridges

3a



Step 3 – Fabricating the superstructure

- Use a standard procedure to fabricate the ceramic coping with the Straumann® CARES® Scan CS2 scanner and the Straumann® CARES® Visual software.

3b



- Veneer the coping with conventional veneering material synchronized to the thermal expansion coefficient of the ceramic coping.
- Coefficient of thermal expansion (CTE) (100–500 °C) $10.80 \pm 0.25 \cdot 10^{-6} \text{ K}^{-1}$
- For veneering follow the recommendations of the ceramic material manufacturer.

3c

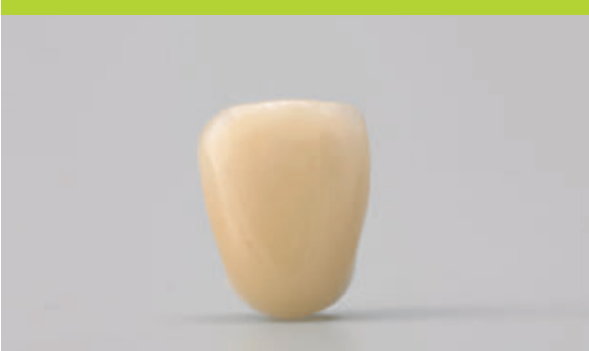

3d



Note

In case of adhesive bonding, sandblast the portions of the abutment surface which will be covered with cement with Al_2O_3 (type 100 microns) at 0.5–1.0 bar (15–30 psi). While sandblasting, the implant configuration must be protected with the polishing aid.

Option B – Screw-retained crowns, directly veneered

3a

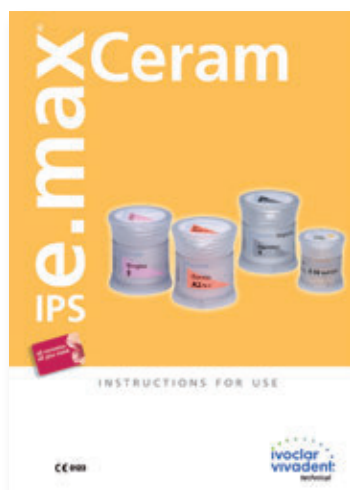

3b



3c

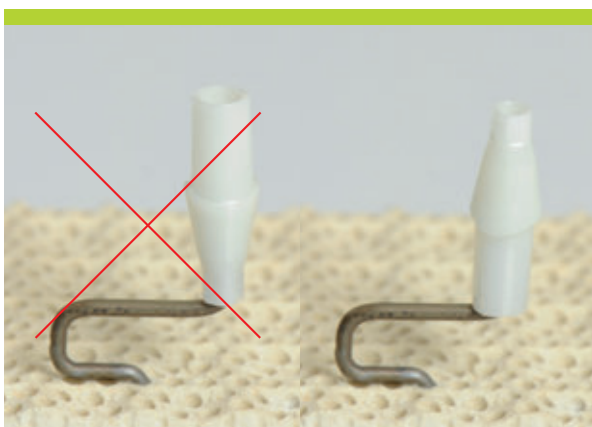

Step 3 – Veneering

- For the veneering of the Straumann® Anatomic IPS e.max® Abutment, use conventional veneering material synchronized to the thermal expansion coefficient of the abutment.
- Coefficient of thermal expansion (CTE):
(100 – 500 °C) $10.80 \pm 0.25 \cdot 10^{-6} \text{ K}^{-1}$
- In this case IPS e.max® Ceram was used. For further details please consult the brochure "Instructions for use IPS e.max® Ceram" (www.ivoclarvivadent.com).
- Steam clean the abutment and apply the IPS e.max® Ceram Zirliner only where IPS e.max® Ceram will be applied later on.
- The implant configuration must be protected with the polishing aid while applying the IPS e.max® Ceram Zirliner.

Note

Do not sandblast the abutment before applying the IPS e.max® Ceram Liner. Avoid any application of IPS e.max® Ceram Zirliner into the screw channel.

Note

Do not apply IPS e.max® Ceram Zirliner on the inner configuration. In case of an adaptation of the emergence profile, it is recommended to place the abutment upside down on the firing tray to prevent the Zirliner from flowing towards the inner configuration during firing.



- Particular attention must be given to an even layer thickness of the porcelain veneered on the abutment.

Note

Observe the maximum thickness of the layering ceramic material (max. 2 mm).



- Final restoration

Option C – Screw-retained crowns using the press-on technique

3a

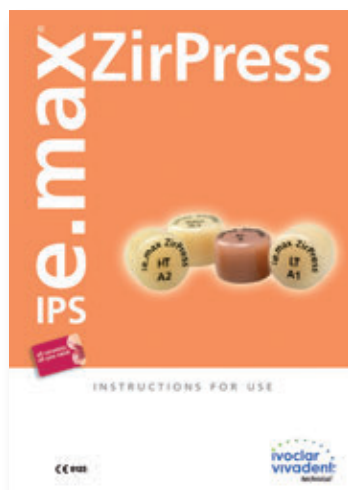

3b



3c

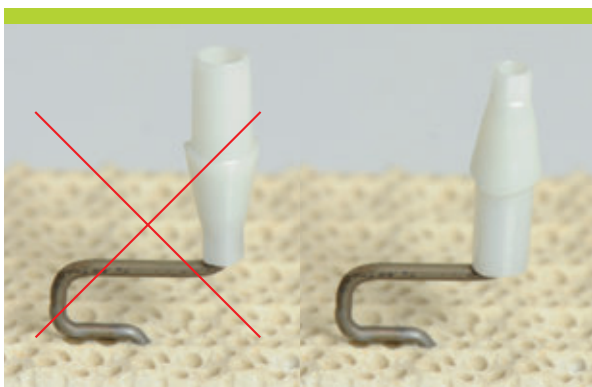

Step 3 – Process of press-on technique

- For pressing onto the Straumann® Anatomic IPS e.max® Abutment, use conventional press-on material synchronized to the thermal expansion coefficient of the abutment.
- Coefficient of thermal expansion (CTE):
(100 – 500 °C) $10.80 \pm 0.25 \cdot 10^{-6} \text{ K}^{-1}$
- In this case IPS e.max® ZirPress was used. For further details please consult the brochure "Instructions for use IPS e.max® ZirPress" (www.ivoclarvivadent.com).
- Steam clean the abutment and apply the IPS e.max® Ceram ZirLiner only where IPS e.max® ZirPress will be applied later on.
- The implant configuration must be protected with the polishing aid while applying the IPS e.max® Ceram ZirLiner.

Note

Do not sandblast the abutment before applying the IPS e.max® Ceram Liner. Avoid any application of IPS e.max® Ceram ZirLiner into the screw channel.

Note

Do not apply IPS e.max® Ceram ZirLiner on the inner configuration. In case of an adaptation of the emergence profile, it is recommended to place the abutment upside down on the firing tray to prevent the ZirLiner from flowing towards the inner configuration during firing.



- Observe the respective material thickness (minimum 0.7 mm up to 2 mm) in order to ensure a proper press-on restoration.



Note

In order to prevent IPS e.max® ZirPress to intrude into the screw channel of the abutment do not cover the screw channel with wax.

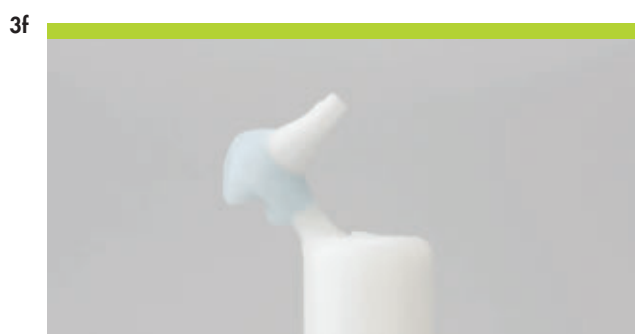

- Sprueing

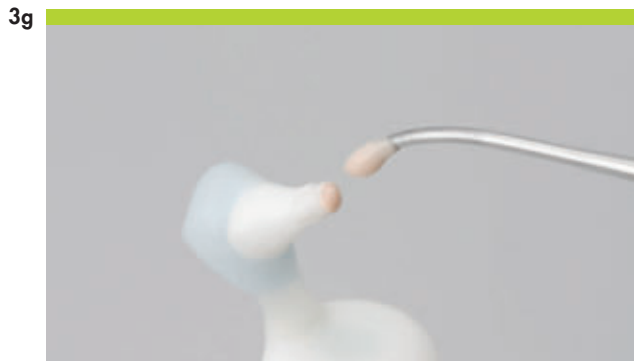

- Cover the whole abutment with investment material and ensure that the screw channel is also completely filled.



- Before pressing, ensure that the pressing furnace is sufficiently preheated.



- The implant configuration must be protected with the polishing aid (e. g. sandblasting).

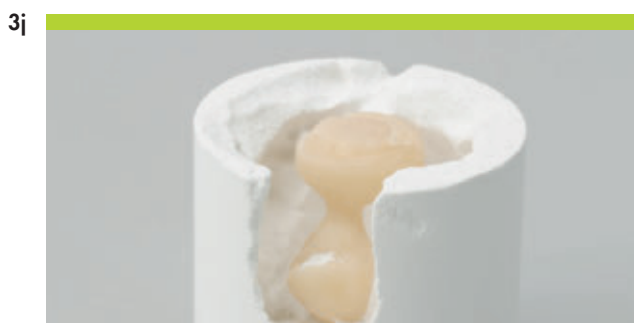

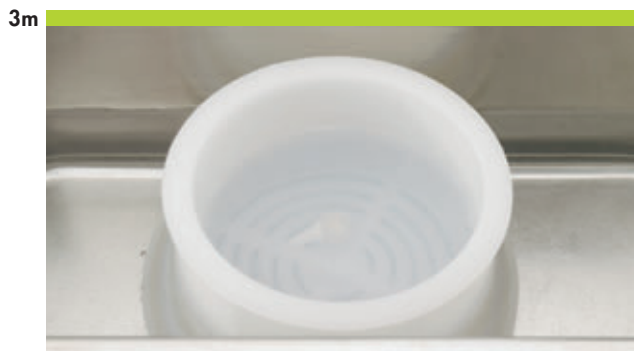
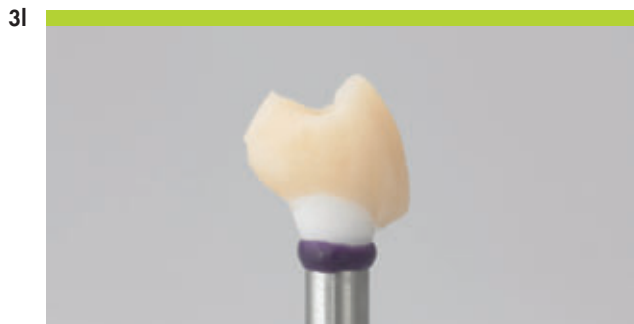

Note

The long-term success of the prosthetic work depends on the accurate fit of the restoration. Therefore the following recommendations must be observed:

- Allow for enough cooling time of the press-on abutment before divestment
- Rough divestment is carried out with glass polishing beads at 4 bar (60 psi) pressure
- Fine divestment is carried out with glass polishing beads at 2 bar (30 psi) pressure
- Do not use Al_2O_3 for rough or fine divestment
- Do not sandblast the conical portion of the abutment and always protect the implant/abutment interface with the polishing aid

- Immerse the pressed objects into the IPS e.max® Press In-vex Liquid (min. 5 minutes, max. 10 minutes) and ensure that they are completely covered.

- Carefully remove the white reaction layer on the pressed objects with Al_2O_3 (type 100 microns) at 1–2 bar (15–30 psi) pressure.

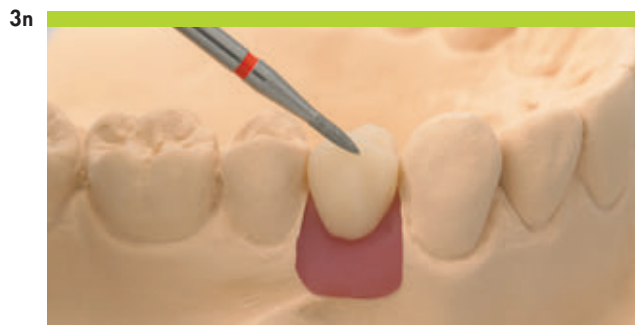

- Veneer, shade and glaze the restoration according to the individual situation.

Note

The implant configuration must be protected with the polishing aid while applying the IPS e.max® Ceram.

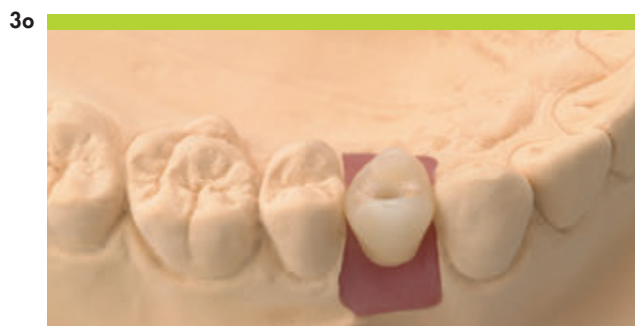

- Final restoration

6.5.2 Straumann® Anatomic IPS e.max® Abutment – Prosthetic procedure

The final restoration is delivered to the doctor's office on the master cast.

Option A – Cement-retained crowns and bridges

Step 1 – Preparation

- Remove the healing cap or temporary restoration.
- Remove the superstructure from the master cast and unscrew the abutment from the analog.
- Clean and dry the interior of the implant and the abutment thoroughly.
- Prepare the surface of the abutment corresponding to the cementation material which will be used (e.g. in case of adhesive bonding apply primer).
- Condition the inner surface of the superstructure according to the instructions for use given by the according manufacturer (e.g. in case of adhesive bonding apply primer).

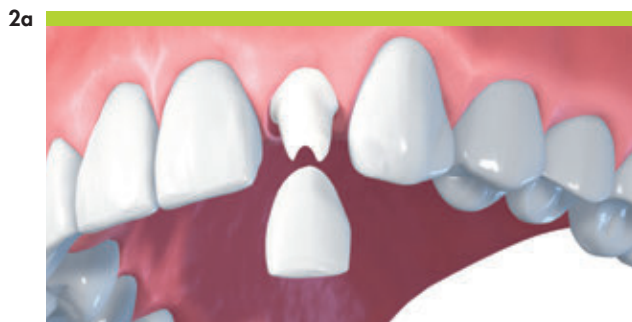

Step 2 – Final Insertion

- Position the cleaned abutment in the implant. Tighten the screw to 35 Ncm using the SCS screwdriver along with the ratchet and the Torque control device (for instructions see chapter 7.5).
- Close the SCS screw channel with cotton and sealing compound (i.e. gutta-percha). This allows for later removal of the modified abutment in the event a restoration replacement is required.
- Cement the superstructure onto the abutment.
- Remove any excess cement.

Note

Only use an original Straumann basal screw for ceramic abutment for the final insertion of the Straumann® Anatomic IPS e.max® Abutment.

Options B + C – Screw-retained crowns, directly veneered or using the press-on technique

Step 1 – Preparation

- Remove the healing cap or temporary restoration.
- Remove the veneered abutment from the master cast.
- Clean and dry the interior of the implant and the abutment thoroughly.

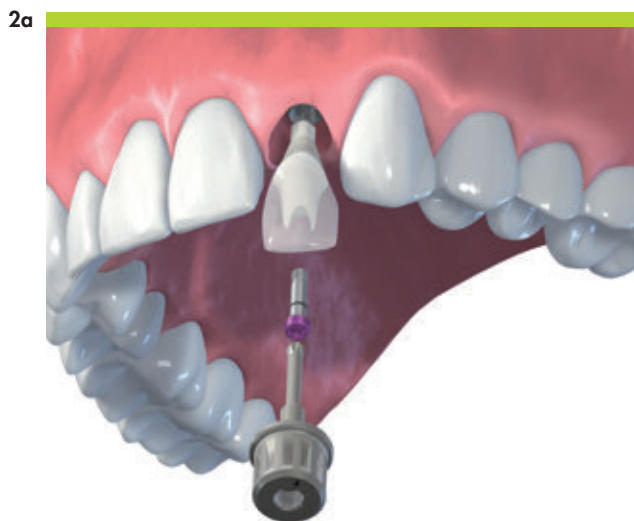

Step 2 – Final insertion

- Position the cleaned and veneered abutment in the implant. Tighten the screw to 35 Ncm using the SCS screwdriver along with the ratchet and the torque control device (for instruction see chapter 7.5).



- Close the SCS screw channel with cotton and sealing compound (i.e. gutta-percha, composite). This allows for later removal of the modified abutment in the event a restoration replacement is required.

Note

Only use an original Straumann basal screw for ceramic abutment for the final insertion of the Straumann® Anatomic IPS e.max® Abutment.

6.5.3 Straumann® Anatomic IPS e.max® Abutment – Chairside procedure for temporary restorations

The following case describes the usage of the Straumann® Anatomic IPS e.max® Abutment chairside.

1



Step 1 – Preparing the Straumann® Anatomic IPS e.max® Abutment

- For preparing the Straumann® Anatomic IPS e.max® Abutment chairside, follow the procedure for cement-retained restorations outlined in step 2 on pages 80–82.
- Following the Ivoclar Vivadent grinding instrument recommendations for IPS e.max®, a regeneration firing for cement-retained crowns and bridges is not required. The regeneration firing has to be conducted if the Ivoclar Vivadent grinding instrument recommendations for IPS e.max® are not followed or if a further thermal processing is necessary. The regeneration firing parameter are:
65 °C (117 °F) per minute heating up to 1050 °C (1922 °F) / 15 minute holding time and long-term cooling down with 25 °C (45 °F) per minute to 750 °C (1382 °F).

2a



Step 2 – Placing the modified Straumann® Anatomic IPS e.max® Abutment

- Place the abutment on the implant and tighten the screw with a torque between 15 Ncm and 35 Ncm using the SCS screwdriver along with the ratchet and the torque control device (for instructions see chapter 7.5).

Note

Before taking the abutment-level impression the abutment needs to be torqued with 35 Ncm.

2b



- Cover the screw head with absorbent cotton or gutta-percha and seal the screw channel temporarily (e.g. with absorbent cotton).

2c

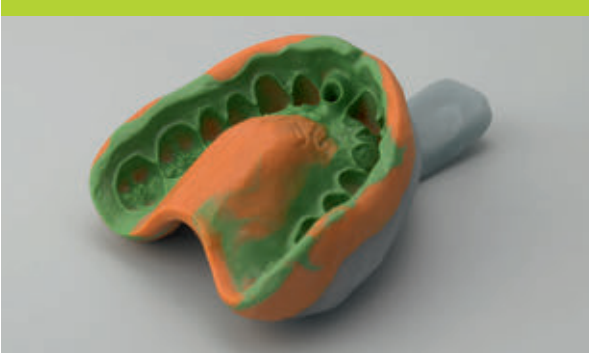

- Take an impression with a custom-made impression tray and order the final restoration.

3

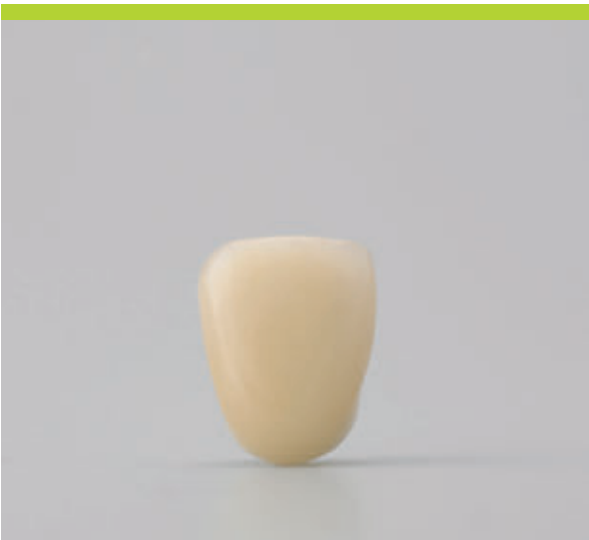

Step 3 – Fabricating the cement-retained temporary single crown

- Use a standard procedure to fabricate the cement-retained single crown (e.g. grind out a prefabricated plastic tooth).

4



Step 4 – Cementing the temporary single crown

- Coat the internal configuration of the crown with temporary cement and cement it onto the Straumann® Anatomic IPS e.max® Abutment.
- Remove any excess cement.

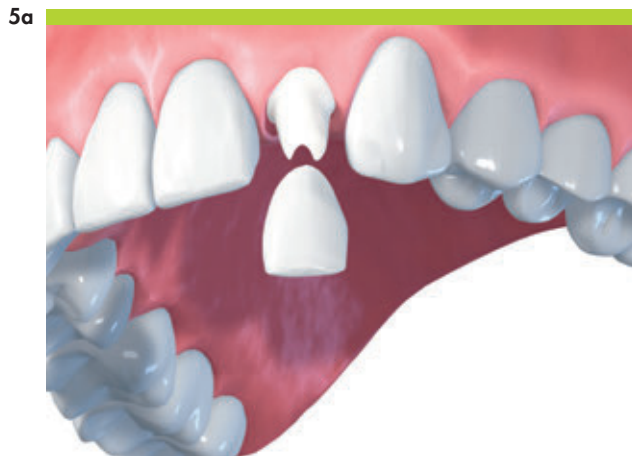

Step 5 – Insertion of the final restoration

- Remove the temporary restoration.
- Clean and dry the interior of the abutment thoroughly.
- Close the SCS screw channel with cotton and sealing compound (i.e. gutta-percha). This allows for later removal of the modified abutment in the event a restoration replacement is required.
- Cement the superstructure onto the abutment.
- Remove any excess cement.

Straumann® CARES® Implant-borne prosthetics

Straumann® CARES® CAD/CAM offers you a range of implant-borne prosthetic solutions in order to achieve high-quality dental implant restorations. Straumann® CARES® implant-borne elements are designed for high reliability and predictability.

All implant-borne prosthetic solutions can be ordered via Straumann® CARES® Visual software. Straumann® CARES® Abutments can also be ordered via the Straumann® CARES® Scan and Shape service.

Straumann® CARES® Abutments

For customized patient solutions

- For cement-retained crowns and bridges via mesostructure
- For screw-retained crowns (ceramic abutments only)
- Available in two different materials: titanium and ceramic

Characteristics

- Customized shape and emergence profile
- Control over cement gap
- Proven Straumann precision fit



Straumann® CARES® Screw-retained bridges and bars

For complex customized patient solutions

- For screw-retained bridges
- For bars (Dolder®, MP-Clip®, Ackermann®, round)
- In two different materials: titanium Grade 4 and cobalt-chromium alloy (coron®)

Characteristics

- Direct connection to the implant, no additional abutment needed
- High precision

For further information regarding Straumann® CARES® Implant-borne prosthetics, please refer to the brochure *Basic information on the Straumann® CARES® implant-borne prosthetic procedures*, 152.822.

6.7 CEMENTABLE ABUTMENT

Intended use

- Cement-retained crowns and bridges

Characteristics

Simple

- Flexible impression taking on implant or abutment level
- Easy handling of prefabricated copings
- Reduce adjustment work (e.g. height adjustment)
- Easy choice of components thanks to color-coding

Reliable

- CrossFit® connection
- Perfect fit due to prefabricated components
- Proper fit of abutment level impression cap verified by clear-cut response

Note

Cement margin must be no more than 2 mm below the gingiva.

A minimum height of 3 mm above the mucosa margin of the abutment must be maintained to ensure proper stability and retention of the restoration.

- Lab procedure: pages 105–108 and 110
- Prosthetic procedure: pages 99–104, 109 and 111



6.7.1 Cementable abutment coding

	Narrow CrossFit®		Regular CrossFit®	
Diameter (D)	3.5 mm (blue coding)	5 mm (yellow coding)	5 mm (grey coding)	6.5 mm (brown coding)
AH 4 mm (black marking)				
AH 5.5 mm (white marking)				

D = Diameter AH = Abutment Height GH = Gingiva Height

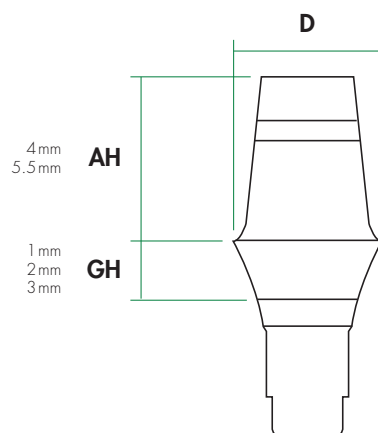

Option A: Impression taking on abutment level – Prosthetic procedure

1a

**Step 1 – Abutment insertion**

- Select the appropriate size of the cementable abutment using the Plan set (for instructions see chapter 6.1).

1b



- Thoroughly clean and dry the interior of the implant.
- Position the abutment in the implant. Tighten the screw to 35 Ncm using the SCS screwdriver along with the ratchet and the torque control device (for instructions see chapter 7.5).

2



Step 2 – Customizing the abutment

- Make height adjustments according to the individual situation. This can be done down to the bottom of the black/white ring.

Note

The abutment-level impression does not carry any information of potential customizations. In this case, the abutment-level impression has to be taken without any auxiliaries. We recommend taking the impression on implant level, and then ask the technician to customize the abutment according to the individual situation.

We recommend customizing the abutment right before the final crown is integrated, if the spatial surroundings allow it (no chewing forces against the abutment). Ask your dental lab to supply you with a grinding template.

3a

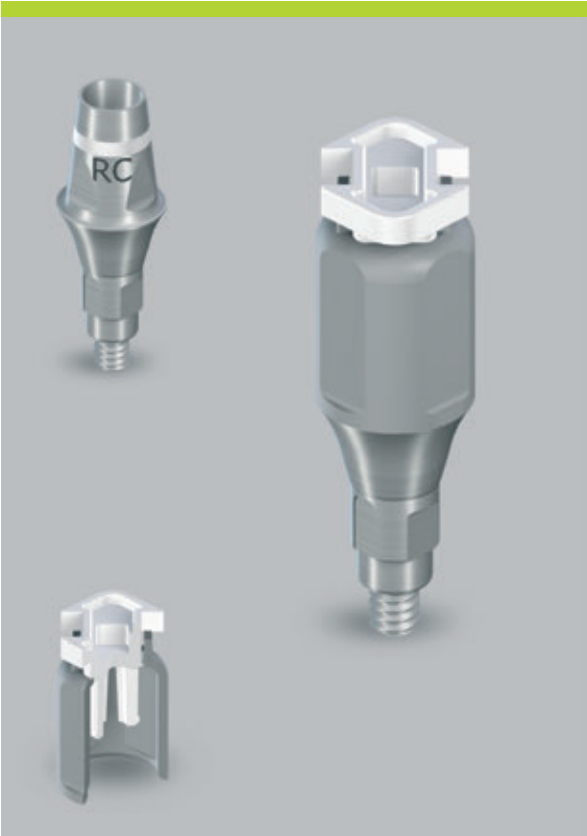

Step 3 – Impression-taking on abutment level

- Click the impression cap onto the abutment.
- The white ring on the abutment indicates the abutment height (AH). It corresponds to the white arrow on top of the impression cap and the white clicking mechanism inside of the impression cap.
- Take the impression using an elastomeric impression material (polyvinyl siloxane or polyether rubber).

3b

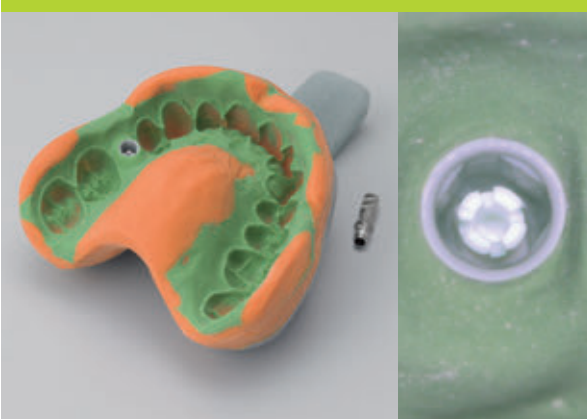

Note

Due to its low tensile strength, hydrocolloid materials are not suitable for this application.

Chairside temporization of the abutment



Temporary coping



Protective cap



Using the temporary coping*

Step 4 – Preparation

- Snap the temporary coping onto the abutment in the mouth of the patient.

- Mark the appropriate height according to the individual situation and shorten the coping as necessary.
- If you intend to provisionalize a bridge, remove the rotational feature of the temporary coping.

Note

Do not use Vaseline (aliphatic isolation agent) for insulation of the abutment.

* For using the protective cap please refer to step 4, page 104.



Step 5 – Creating the provisional

- Use a standard procedure to fabricate the provisional (e.g. prefabricated crown form or vacuum-formed sheet technique). The retention rings ensure proper mechanical bonding of the veneering material to the coping. The plateau of the coping helps to prevent the veneering material from flowing under the abutment.
- After the polymerization is completed, take the provisional out of the mouth and place it on the analog.
- Grind down and polish the emergence profile of the coping and the restoration to achieve an even profile. To avoid tissue irritation, the interface needs to be smooth and flush with the restoration.

6



Step 6 – Inserting the provisional

- Close the SCS configuration of the screw with cotton and sealing compound (e.g. gutta-percha). This allows a later removal of the provisional.
- Apply temporary cement to the inner part of the coping and cement it onto the abutment.

Note

Keep the temporary restoration out of occlusion.

Use temporary cement in order to remove the temporary restoration in due time.

Do not keep the temporary copings in the patient's mouth for longer than 30 days.

4



Using the protective cap

Step 4 – Cementing the protective cap

- Close the SCS configuration of the screw with cotton and sealing compound (e.g. gutta-percha). This allows a later removal of the provisional.
- Apply temporary cement to the inner part of the protective cap and cement it onto the abutment.

Note

Use temporary cement in order to remove the temporary restoration in due time.

Do not keep the protective caps in the patient's mouth for longer than 30 days.

Lab procedure

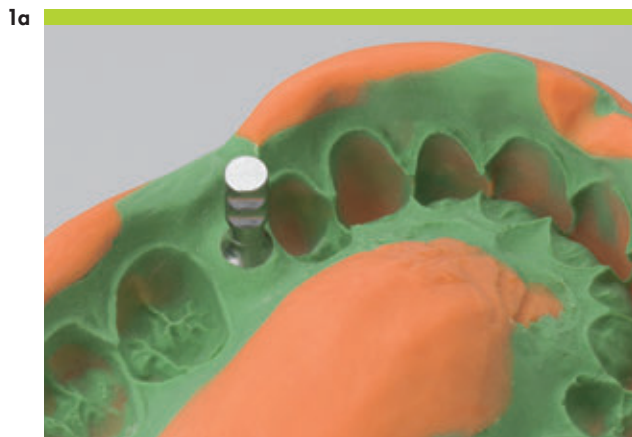

Step 1 – Fabricating the master cast

- Click the corresponding analog in the impression.

Note

Ensure that the color code of the analog corresponds to the color code of the impression cap.

The white ring on the abutment indicates the abutment height (AH). It corresponds to the white arrow on top of the impression cap and the white clicking mechanism inside of the impression cap.

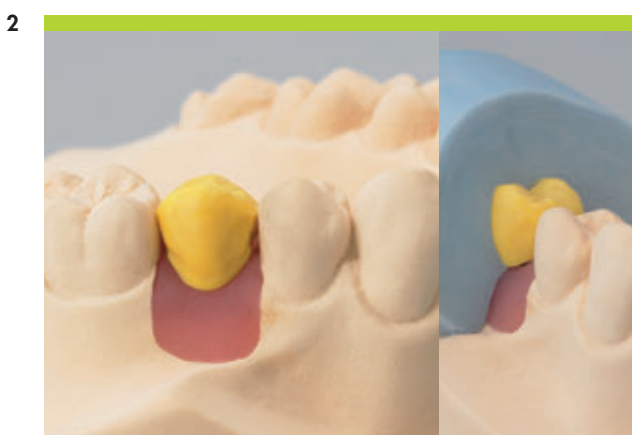

Step 2 – Preparation

- Fabricate the master cast using standard procedure (for instructions see chapter 5).
- Model a full anatomical wax-up for optimal esthetic planning. Use the corresponding burn-out coping as a basis for this wax-up.
- Make a silicone key over the full wax-up in order to define the optimal shape of the restoration.

3



Step 3 – Customizing

- Depending on the individual situation, height adaptations can be made without harming the anti-rotational grooves.
- Individualize the abutment portion of the analog according to the individual situation.
- Fabricate a grinding template for the practitioner. This will enable the precise transfer of the individualization into the mouth of the patient.

Note

To ensure proper stability and retention of the restoration, a minimum height of 3 mm above the mucosa margin of the abutment must be maintained.



Step 4 – Fabricating the crown

- Select the burn-out coping and place it on the analog.

- Shorten the burn-out coping if necessary.

- Fabricate the superstructure on the (modified) abutment using standard modeling methods.

- Check the wax-up with the silicone key.

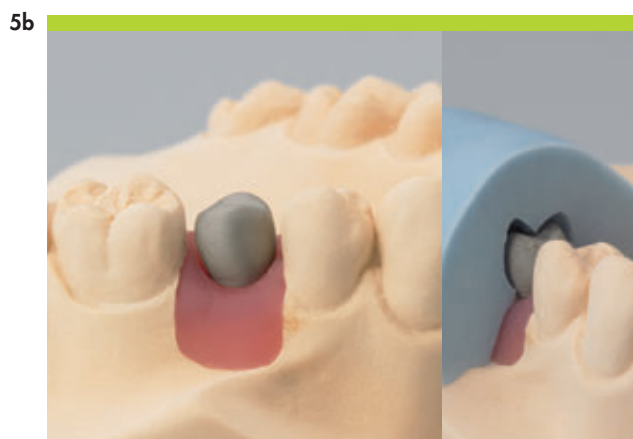

Step 5 – Casting and veneering

- Cast the framework using standard procedures.
- Adjust the framework so that it can be attached to the analog. Remove the clamping ring using a circular motion. Do not harm the rotational faces nor the exact margin fit.

- Check the spatial conditions with the silicone key.

- Veneer the superstructure.

Prosthetic procedure

The final restoration is delivered to the doctor's office on the master cast.

1



Step 1 – Final insertion

- Remove the temporary restoration using standard procedure.
- If necessary, do the required customization of the abutment by using the reduction coping from the dental technician.
- Clean the abutment thoroughly and remove all remaining temporary cement.
- Cement the crown to the abutment.
- Remove superfluous cement.

Option B: Impression taking on implant level

Take the impression according to the instructions in chapter 5.

Lab procedure



Step 1 – Abutment insertion

- Select the correct size of the cementable abutment by using the Plan set (for instructions see chapter 6.1).
- Hand-tighten the abutment on the analog in the master cast.



Step 2 – Customizing

- Make height adaptations according to the individual situation without harming the anti-rotational grooves.

Note

To ensure proper stability and retention of the restoration, a minimum height of 3 mm above the mucosa margin of the abutment must be maintained.

Follow the corresponding steps as described for the impression on abutment level (page 99).



- Apply the transfer aid and attach it to the adjacent teeth.
- Deliver the customized abutment with the attached transfer aid and the final restoration to the doctor's office for insertion.

Prosthetic procedure

The final restoration is delivered to the doctor's office on the master cast.

1



Step 1 – Final insertion

- Position the cleaned abutment in the implant. Tighten the screw to 35 Ncm using the SCS screwdriver along with the ratchet and the torque control device (for instructions see chapter 7.5).
- Insert the abutment together with the transfer aid for a better orientation.
- Close the SCS configuration of the screw with cotton and sealing compound (e.g. gutta-percha). This later allows removal of the abutment.
- Cement the crown to the abutment.
- Remove superfluous cement.

6.8 STRAUMANN® SCREW-RETAINED ABUTMENTS

Intended use

- Screw-retained multi-unit as well as single-unit restorations on abutment-level
- Full-arch restorations on abutment-level, screw-retained as well as removable

Sleek design and clear portfolio

- Same low abutment connector design for all diameters allows a streamlined portfolio of tertiary components
- Abutment angulations of 17° and 30°
- Abutment design allows multi-unit as well as single-unit restorations
- 2 diameters cover the complete Straumann® Bone Level product line
- Different gingiva heights of 1 mm, 2.5 mm, 4 mm and 5.5 mm
- Simplified handling with the CrossFit® connection

Important information

Straumann® Screw-retained Abutments, straight NC GH 1.0 mm (Ø 3.5 mm and Ø 4.6 mm*), are indicated for single-crown restorations of central and lateral incisors and for multi-unit restorations of incisors to pre-molars:















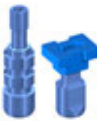

Abutments will be delivered premounted with the Transfer and Alignment Pin starting late 2015.

		Single-unit restoration	Multi-unit restorations (incisor to premolar region)	Multi-unit restorations (molar region)
NC Ø 3.5 mm straight abutments	GH 1 mm	Only central/lateral incisors	Yes	No
	GH 2.5/4 mm	Yes	Yes	No
NC Ø 4.6 mm straight abutments	GH 1 mm	Only central/lateral incisors*	Yes	No
	GH 2.5/4 mm	Yes	Yes	No
NC Ø 4.6 mm angled abutments		Yes	Yes	No
RC Ø 4.6 mm straight abutments		No limitation		
RC Ø 4.6 mm angled abutments		No limitation		

*valid for article number 022.2747, new article number 022.2747P also indicated for single-crown restorations of incisors up to premolars.

Straumann® Screw-retained abutment – Color coding

	Narrow CrossFit®			Regular CrossFit®	
Diameter	3.5	4.6		4.6	
Angulation	0°	0°	17° 30°	0°	17° 30°
					
Coding	Blue	Yellow		Grey	
Abutment height	1.8 mm	1.8 mm		1.8 mm	
Abutment connector angle	22°	22°		22°	
Gingiva heights	1 mm 2.5 mm 4 mm	1 mm 2.5 mm 4 mm	2.5 mm 4 mm 5.5 mm	1 mm 2.5 mm 4 mm	2.5 mm 4 mm 5.5 mm
Impression components*					
	*impression components are available as non-engaging (for bridges) and engaging components (for crowns)				
Abutment screws	Straight	Straight abutments Angled abutments			
					
Tightening force abutment screw	35 Ncm				
Occlusal screw					
Tightening force occlusal screw	15 Ncm				
Lab processing screw					
Lab polishing aid					
Analogs and repositionable analogs					

Straumann® Screw-retained Abutment – Technical information

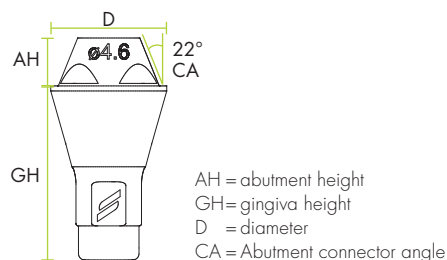

Engaging / non-engaging feature



Ø 3.5 mm		Ø 4.6 mm	
NC		NC	RC
Available as engaging and non-engaging		Total 5 copings Available as engaging and non-engaging	

* only available as non-engaging

Preparation – Select the right abutment using the Plan abutments

Plan abutments for the new screw-retained abutments are available in gingiva height (GH) 2.5 mm and in orientations A and B.



Select the appropriate size of the abutment using the Plan set.

Preparation – Abutment placement

Clean and dry the interior of the implants thoroughly.

Position the abutments in the implants. Tighten them to 35 Ncm using the SCS screwdriver along with the ratchet and the torque control device.

For easier positioning of the abutments in the posterior region, make use of the Transfer and Alignment Pin.



Note

Do not modify the abutments. For processing in the dental lab use the Lab Processing screws.

Preparation – Impression-taking on abutment level

General: It is recommended to take the impression on the level that the final restoration is planned on to ensure proper fit of the temporary and final restoration:

- Abutment-level impression for restoration on abutment level
- Implant-level impression for restoration on implant level



Open-tray impression

Make sure the abutments are torqued down with 35 Ncm. Place the open-tray impression posts onto the abutments and fix them with the screw.

Ensure correct positioning of the impression posts on the abutments.

For single-unit restoration use the impression components with the engaging feature, for multi-unit restorations use the impression components with the non-engaging feature.



Take the impression using an elastomeric impression material.

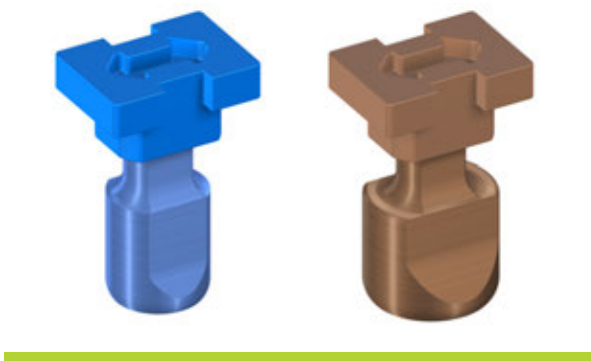

Closed-tray impression

Make sure the abutments are torqued down with 35 Ncm.

Place the closed-tray impression posts onto the abutments and fix them with the screw.

Ensure correct positioning of the impression posts on the abutments.

Position the positioning cap onto the impression post.



For single-unit restoration use the impression components with the engaging feature, for multi-unit restorations use the impression components with the non-engaging feature.

Take the impression using an elastomeric impression material.

Forward the impression and all corresponding impression components to the dental lab.

Preparation – Impression taking on implant level (option)

In case all implants are placed straight, there is the option of taking an implant-level impression (for instructions see chapter 5. *Impression taking*).



Single-unit restoration (tooth position #1)



Temporary restoration

Using protective caps

Mount the protective cap onto the abutment and hand-tighten the screws with the SCS screwdriver.

Note

Do not keep protective caps in the patient's mouth for longer than 30 days.

Using titanium copings

Based on the dental impression prepare the master cast using the appropriate analog.

Place the titanium coping with engaging features onto the analog.

Modify the titanium coping according to the required length.

Seal the screw channels.

Sandblast the coping and coat it with opaquer to avoid titanium shining through.

Use a standard procedure to create the temporary crown.

Remove excess material, re-open the screw channel and finalize the temporary crown.





Insert the provisional into the patient's mouth with a torque of 15 Ncm.

Cover the screw channel with absorbent cotton or gutta-percha and seal the screw channel.

Note

Keep the temporary restoration out of occlusion.

Final restoration

Using gold copings

- For this procedure use the gold coping with the engaging feature.

Fix the corresponding analog into the impression.

Note

Ensure that the color code of the analog corresponds to the color code of the impression components.

Fabricate the master cast using standard procedure (for instructions see chapter 5. *Impression taking*).

Model a full anatomic wax-up for optimal esthetic planning. Use the corresponding gold copings or burn-out copings as a base for the wax-up.



You can define the optimal shape of the restoration by making a silicone key over the full wax-up.

Place the gold coping on the analog and hand-tighten the occlusal screw using the SCS screwdriver.



Shorten the modeling aids to the height of the occlusal plane according to the individual situation. Working with the modeling aid ensures a clean and sharp-edged finish of the screw channel.



Fabricate the superstructure on the abutments using standard modeling procedure.

Make sure that the wax layer on the abutment is sufficiently thick (at least 0.7 mm). Do not cover the delicate margin of the coping with wax.



Check the spatial conditions before casting the crown framework with the silicone key of the wax-up.

Before investing the wax framework, make sure the framework is tensionfree.

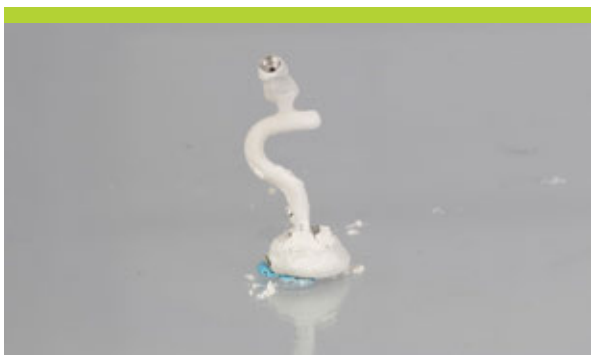
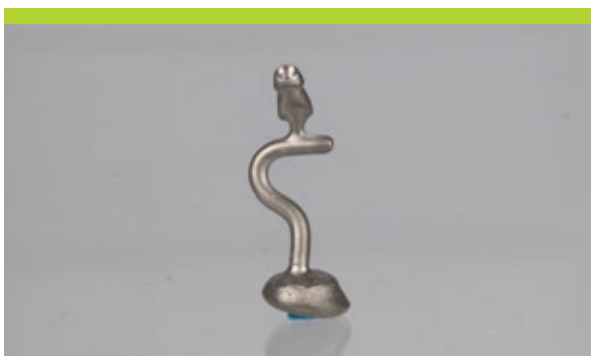

Note

In order to avoid overflow of the cast-on alloy, clean the copings thoroughly prior to investment (removal of wax particles and insulating agents with a cotton pellet or brush moistened with alcohol).

Ensure that there is no wax on the delicate margin.

The use of investment materials for rapid heating methods (speed investment materials) is not recommended.

When processing the investment material, follow the manufacturer's instructions. Strictly observe the recommended mixing ratio and preheating time.

Make sure the screw channel and the internal configuration of the copings are filled with investment material from the bottom to the top in order to avoid air bubbles (see pictures).

Long-term success of the prosthetic work depends on the accurate fit of the restoration. The entire procedure will have to be repeated if casting errors occur.



Invest the framework according to standard methods without using wetting agents.

Cast and deinvest the framework using standard methods.

Check for tension-free fitting on the master cast by applying the Sheffield test.

Do an additional try-on of the tensionfree fit of the crown in the patient's mouth.

Veneer the superstructure.

Note

Alternatively, burn-out copings may be used.

Multi-unit restoration (tooth position #4-6)



Temporary restoration

Using the protective caps

Mount the protective caps onto the abutment and hand-tighten the screws with the SCS screwdriver.

Note

Do not keep protective caps in the patient's mouth for longer than 30 days.

Using titanium copings

Based on the dental impression prepare the master cast using the appropriate analogs.

Place the titanium copings with engaging features onto the analogs.

Modify the titanium copings according to the required length.

Seal the screw channels.

Sandblast the copings and coat them with opaquer to avoid titanium shining through.



Use a standard procedure to create the temporary bridge.



Remove any excess material, re-open the screw channels and finalize the temporary bridge.



Insert the temporary bridge into the patient's mouth at 15 Ncm.

Cover the screw channels with absorbent cotton or gutta-percha and seal the screw channel.

Note

Keep the temporary restoration out of occlusion.

Final restoration

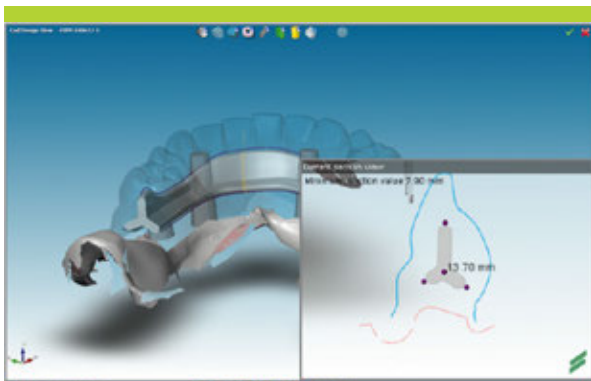

Final restoration using CAD/CAM system

Fabricate the master cast using standard procedure (for instructions see chapter 5. *Impression taking*).

In order to transfer the impression data into the CARES® software use abutment-level scanbodies for the screw-retained abutments.

Hand-tighten the scanbodies onto the analogs in the dental model.

Place the dental model in the scanner and follow the scanning instructions.

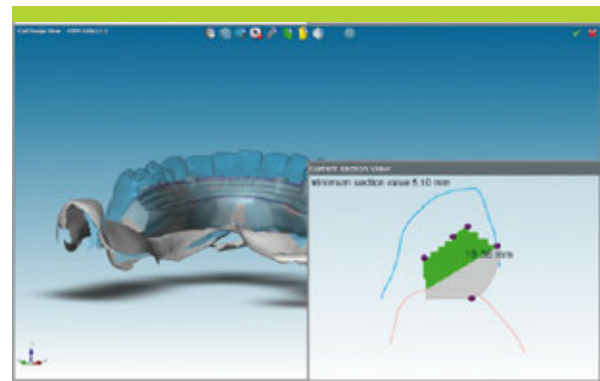

Design the framework in the software as needed.

Transfer the final design to the milling facilities.



Veneer the custom-milled superstructure.

In case you do not have access either to Straumann® CARES® or Createch, the final restoration can be prepared using standard procedure.

Using gold copings

- For this procedure non-engaging gold copings are used.

Fix the corresponding analogs into the impression.



Note

Ensure that the color code of the analogs corresponds with the color code of the impression components.

Fabricate the master using standard procedure (for instructions see chapter 5. *Impression taking*).

Model a full anatomic wax-up for optimal esthetic planning. Use the corresponding gold copings or burn-out copings as a base for the wax-up.



You can define the optimal shape of the restoration by making a silicone key over the full wax-up.





Place the gold copings on the analogs and hand-tighten the occlusal screw using the SCS screwdriver.



Shorten the modeling aids to the height of the occlusal plane according to the individual situation. Working with the modeling aid ensures a clean and sharp-edged finish of the screw channel.



Fabricate the superstructure on the abutments using standard modeling procedures.

Make sure that the wax layer on the abutment is sufficiently thick (at least 0.7 mm). Do not cover the delicate margin of the coping with wax.



Check the spatial conditions before casting the crown framework with the silicone key of the wax-up.

Before investing the wax framework make sure the framework is tensionfree.



Note

In order to avoid overflow of the cast-on alloy, clean the copings thoroughly prior to investment (removal of wax particles and insulating agents with a cotton pellet or brush moistened with alcohol).

Ensure that there is no wax on the delicate margin.

The use of investment materials for rapid heating methods (speed investment materials) is not recommended.

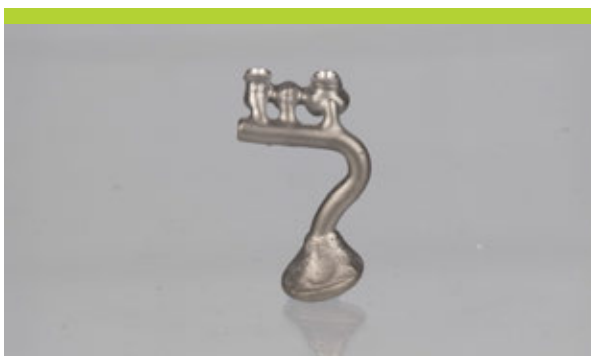

When processing the investment material, follow the manufacturer's instructions. Strictly observe the recommended mixing ratio and preheating time.

Make sure the screw channel and the internal configuration of the copings are filled with investment material from the bottom to the top in order to avoid air bubbles (see picture).

Long-term success of the prosthetic work depends on the accurate fit of the restoration. The entire procedure will have to be repeated if casting errors occur.



Invest the framework using standard procedure without using wetting agents.

Cast and deinvest the framework using standard procedure.

Check for tension-free fitting on the master cast by applying the Sheffield test. If the bridge is not tension-free and wiggles, cut the bridge and resplint tension-free.



Do an additional try-on of the tensionfree fit of the bridge in the patient's mouth.

Veneer the superstructure.

Note

Alternatively, burn-out copings can be used.

Edentulous restoration: Fixed option with immediate temporary restoration.



Temporary restoration

Using protective caps

Mount the protective caps on the abutment and hand-tighten the screws with the SCS screwdriver.

Note

Do not keep protective caps in the patient's mouth for longer than 30 days.

Using titanium copings

- In this case the preparation of an immediate provisional in the dental lab is shown.



Based on dental impression, prepare the master cast using standard procedure.

Based on the impression and bite registration, prepare the provisional denture.

For the surgical procedure, prepare a duplicate of the provisional in clear acrylic material.

At the day of surgery the surgeon will provide the clinical patient information.

Titanium copings will represent the implant position and angulation in the acrylic guide.



Note

For more detailed information on the surgical procedure, please see the Basic information on screw-retained hybrid restorations – Straumann® Pro Arch, 490.015.



In the dental lab, prepare holes in the temporary denture according to the number of titanium copings. Consider sufficient space for resin material.



Check if there is sufficient space for the titanium copings.



In the patient's mouth, connect the titanium copings with the temporary prosthesis using resin material and transfer to the dental lab for finalizing.



In the dental lab, finalize and polish the temporary restoration.



Note

In order to protect the abutment configuration from resin flowing in, use the polishing aids.



Final restoration: Screw-retained – CAD/CAM option

Fabricate the master cast using standard procedure (for instructions see chapter 5. *Impression taking*).

In order to transfer the impression data into the CARES® software, use abutment-level scanbodies for the screw-retained abutments.



Hand-tighten the scanbodies onto the analogs in the dental model.



Place the dental model in the scanner and follow the scanning instructions.

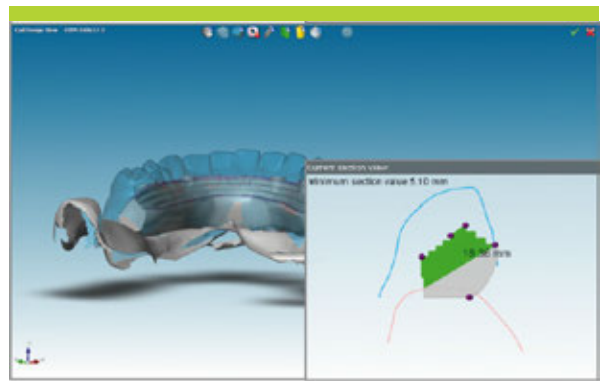
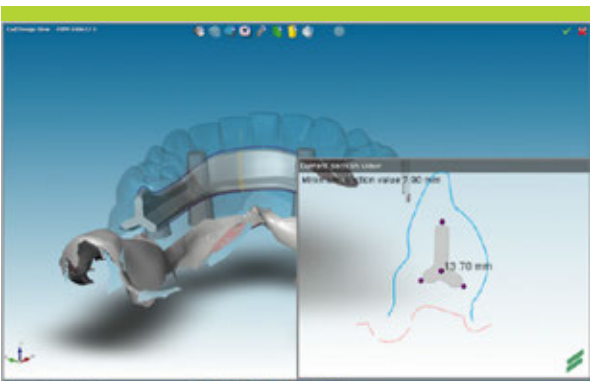

Design the framework for screw-retained restorations in the software as needed. Transfer the final design to the milling facility.



Example of a Straumann® CARES® Advanced Fixed Bar on 4 implants



Example of a Straumann® CARES® Basic Fixed Bar on 4 implants

Veneer and finalize the custom-milled superstructure.

CARES® Advanced Fixed Bar



CARES® Basic Fixed Bar

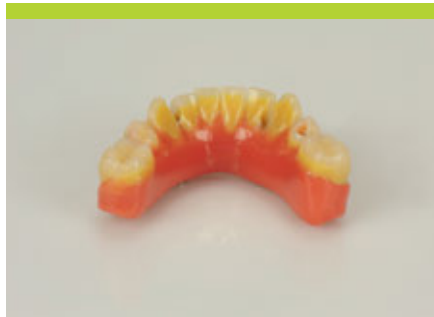

Final restoration: Conventional option



Final restoration: Removable – Conventional option

Using traditional Dolder® bars

Fix the corresponding analogs into the impression.

Note

Ensure that the color code of the analogs corresponds with the color code of the impression components.

Fabricate the master cast using standard procedure (for instructions see chapter 5. *Impression taking*).

Before placing the copings onto the master cast, we recommend mounting the occlusal screw onto the SCS screwdriver. Place the bar copings onto the master cast and hand-tighten with the occlusal screws.

Fabricate a soldered or laser-welded titanium bar using standard procedure.

Note

Use stabilization pins for the soldering of a gold bar.

Remove the temporary restoration before inserting the final restoration.

Clean the abutments thoroughly in the patient's mouth.

Check tension-free fit of the bar before tightening.



Tighten the occlusal screw to 15 Ncm using the SCS screwdriver with the ratchet and the torque control device.



Note

For more detailed information on Straumann® CARES® Basic and Advanced Fixed Bars, please refer to *Basic Information on CARES® Basic and Advanced Fixed Bars – Prosthetic Finalization*, 490.042.

6.9 ABUTMENT FOR BARS

Intended use

- Bar-retained implant-borne dentures in the mandible and maxilla
- Stabilisation and primary splinting of the implants

Characteristics

Simple

- Effective one-piece solution provides uncomplicated bar restorations for standard situations.
- A 15° cone allows implant divergence flexibility up to 30°.
- Abutment can be easily shortened due to 7 mm distance from soft tissue level.

Reliable

- Flexible design for soldered and laser-welded bar constructions with prefabricated components

Note

Use a new basal screw for the final insertion of the abutment.



- Lab procedure: pages 137–144
- Prosthetic procedure: page 145

6.9.1 Abutment for bars – Lab procedure

1



Step 1 – Fabricating the master cast

- Fabricate the master cast using standard procedures and type-4 dental stone (DIN 6873).

2a



Step 2 – Preparation

- Place the abutment for bars on the analogs and hand-tighten the screw using the SCS screwdriver.

2b



Soldered gold bar

(For the lab procedure of a **laser-welded titanium bar** continue at step 3 on page 142.)

3



Step 3 – Placing the bar segments

- Place the individual bar segments between the abutment units.

Note

The space between the bar and the gingiva must be at least 2 mm. To achieve a good joint, the gap between the abutment and the bar should be as small as possible.

4a



Step 4 – Fixation of the bar segments

- Use a residue-free burn-out plastic to fix the bar segments to the abutments.

Note

Do not cover the basal screws.

4b

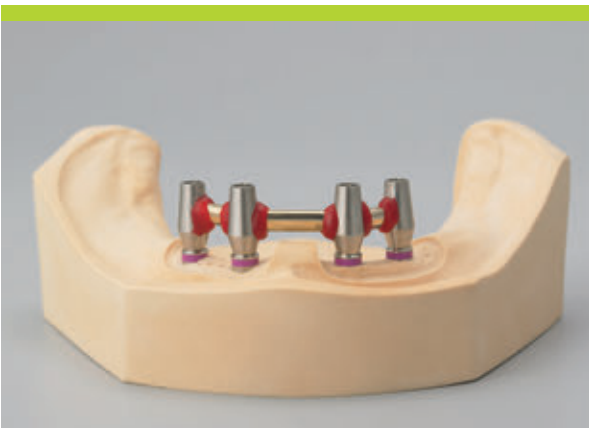

5

**Step 5 – Removing the bar framework**

- Carefully remove the bar framework after loosening the screws.
- Place the framework on the polishing aids and hand-tighten the screws. The polishing aids ensure that the abutments are anchored accurately in the soldering investment during soldering.



Step 6 – Soldering the bar

Note

To prevent possible distortion of the bar through uneven preheating with the flame, preheat the soldering investment to 500–600 °C (932–1112 °F) in a preheating furnace.

- After preheating, solder the invested bar according to standard procedure.
- Once soldering is complete, cool down the investment to room temperature.
- Devest and clean the bar in an ultrasonic bath.
- Remove the oxides and soldering flux residues in an acid bath.

Note

Do not sandblast the framework.

- Check the fit.

Note

Stress-free repositioning of the bar on the implant analogs should be possible without securing it with the screws.

6d



- Shorten the bar in height if necessary and polish it.

6e



- Send the finished bar with 4 new basal screws to the doctor's office.

Note

At this point the screws used for soldering are extremely oxidized. Therefore, do not use them to secure the bar in the mouth.

Laser-welded titanium bar



Step 3 – Placing the bar segments

- Fit the bar segments to the master cast, allowing for a certain gap that will be offset by the addition of titanium (see graphic 3b).

Note

The space between the bar and the gingiva must be at least 2 mm.

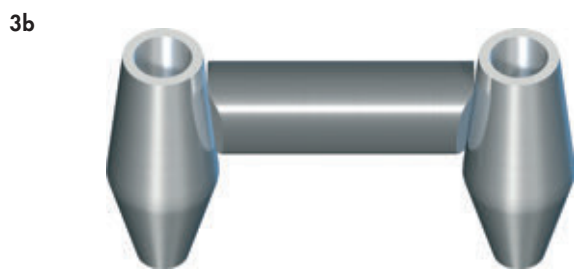



Step 4 – Welding of the segments

- Weld the segments together with adequate argon gas rinsing.



- Check the fit.



- If necessary, shorten the height of the bar and polish it.

Note

Stress-free repositioning of the bar on the implant analogs should be possible without securing it with the screws.

4d



- Send the finished bar with 4 new basal screws to the doctor's office.

Note

At this point the screws used for soldering are extremely oxidized. Therefore, do not use them to secure the bar in the mouth.

6.9.2 Abutment for bars – Prosthetic procedure

The final restoration is delivered to the doctor's office on the master cast.

1



Step 1 – Final insertion

- Position the cleaned bar in the implants. Ensure the stress-free repositioning of the bar on the implants.
- Tighten the screw to 35 Ncm using the SCS screwdriver along with the ratchet and the torque control device (for instructions see chapter 7.5).

6.10 LOCATOR® ABUTMENT

Intended use

- Dentures retained by implants in the mandible and maxilla

Characteristics

Simple

- Divergence compensation up to 40° between two implants
- Minimum component height for limited occlusal space

Reliable

- Dual retention for optimal abutment-denture connection
- Excellent long-term performance due to high wear resistance of components



Manufacturer

Zest Anchors, Inc.
Escondido, CA 92029
USA

- Lab procedure: pages 147–150
- Prosthetic procedure: pages 151–158

6.10.1 LOCATOR® Abutment – Lab procedure

Option A: Master cast from implant-level impression

Take the impression according to the instructions in *chapter 5*.

1



Step 1 – Selecting the abutment height

- Select the height of the LOCATOR® abutment by determining the height of the replica gingiva at its highest point on the master cast. Example: Pick the LOCATOR® abutment height 2 mm if the gingival height is 2 mm. The abutment is designed in a way that the top margin of the abutment will be 1 mm above the mucosa.

Note

Inserting the prosthesis is easier for the patient when the LOCATOR® abutments are on the same horizontal level.

2

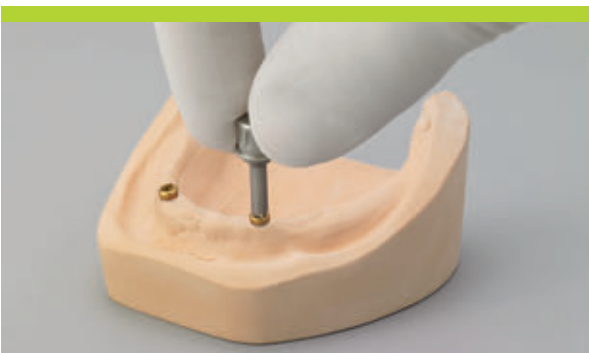

Step 2 – Abutment insertion

- Screw the abutment hand-tight into the implant analog using the LOCATOR® driver.

Option B: Master cast from abutment-level impression

For abutment-level impression taking, special LOCATOR® analogs are used. The selection of the LOCATOR® abutments has already been made by the prosthodontist.

1



Step 1 – Female analog insertion

- Insert the LOCATOR® female analogs into the LOCATOR® impression copings.

2



Step 2 – Fabricating of the master cast

- Fabricate the master cast using standard procedure and type-4 dental stone (DIN 6873).

Construction of an overdenture with LOCATOR® denture housings

You can construct a new overdenture or upgrade an already existing and well-functioning overdenture with LOCATOR® components.

Option A: Construction of a new overdenture

1



Step 1 – Placing the white block-out spacers and denture caps

- Place one white block-out spacer over each abutment.
- Place the denture caps with the black processing males onto the LOCATOR® abutments, or the LOCATOR® analogs in the master cast.

2



Step 2 – Overdenture construction

- Construct the overdenture according to the standard procedure, adding the LOCATOR® denture housing.
- Return the completed overdenture to the doctor's office with the black processing males still in place.

Option B: Upgrading an existing overdenture

1



Step 1 – Placing the white block-out spacers and denture caps

- Place one white block-out spacer over each abutment.
- Place the denture caps with the black processing males onto the LOCATOR® abutments, or the LOCATOR® analogs in the master cast.

2



Step 2 – Hollowing out the denture base

- Hollow out the existing denture base in the areas of the LOCATOR® denture caps.

3



Step 3 – Over-denture rebase

- Rebase the over-denture according to the standard procedure, adding the LOCATOR® denture housing.
- Return to the dentist the completed over-denture with the black processing males still in place.

6.10.2 LOCATOR® Abutment – Prosthetic procedure (standard)

Impression taking

Option B: Abutment-level impression taking

For abutment-level impression taking, special LOCATOR® impression components are used. As a consequence, abutment heights are selected by the doctor on the patient.

1



Step 1 – Selecting the abutment height

- Make sure the top of the implant is not covered by hard or soft tissue.

Note

It is imperative that all hard and soft tissue is removed from the implant shoulder to ensure correct seating of the LOCATOR® abutment.

- Select the height of the LOCATOR® abutment by determining the height of the gingiva at its highest point in the patient's mouth. Choose the corresponding abutment tissue cuff height or the closest higher size available.

Note

Prosthesis insertion is easier for the patient if the LOCATOR® abutments are on the same horizontal level.

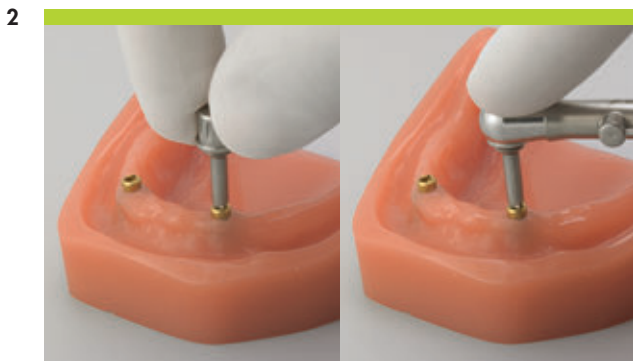

Step 2 – Abutment insertion

- Screw the abutment into the implant hand-tight, using the LOCATOR® driver.
- Tighten the abutment to 35 Ncm using the ratchet along with the torque control device (for instructions see chapter 7.5) and the LOCATOR® driver (see chapter 6.10.4).

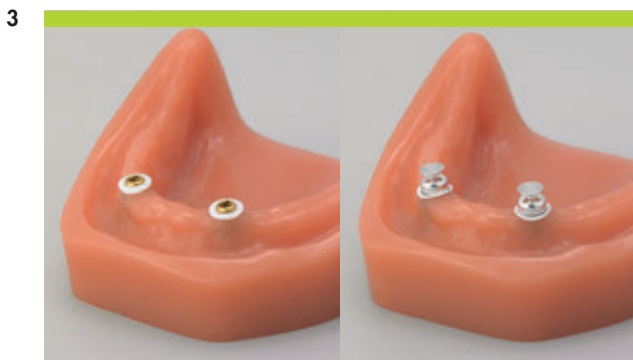

Step 3 – Placing spacer and impression coping

- Place a white block-out spacer ring on each abutment. The spacer ring is used to block out the area surrounding the abutment.
- Place the LOCATOR® impression copings on the LOCATOR® abutments.



Step 4 – Impression taking

- Take the impression utilizing the mucodynamic technique (vinyl polysiloxane or polyether rubber).
- Send the impression to the dental laboratory.

Final restoration



The dental technician returns the completed LOCATOR® overdenture to the doctor's office for final placement. The finished denture is delivered with the black processing males still in place.

1



Step 1 – Selecting the replacement males

- Implant divergence up to 10° for a single implant:

Color	Retention
● blue	0.68 kg
● pink	1.36 kg
● clear	2.27 kg

- Implant divergence between 10° and 20° for a single implant:

Color	Retention
● gray	0.0 kg
● red	0.45 kg
● orange	0.91 kg
● green	1.82 kg

Note

Always start with the lowest retention replacement males (see chapter 6.10.4).

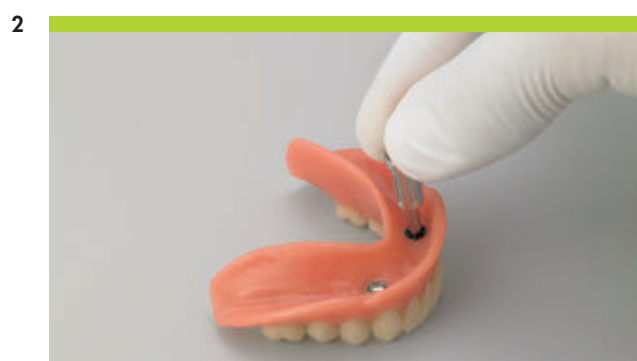

Step 2 – Removing the processing males

- Remove the black processing males from the housing (see chapter 6.10.4).

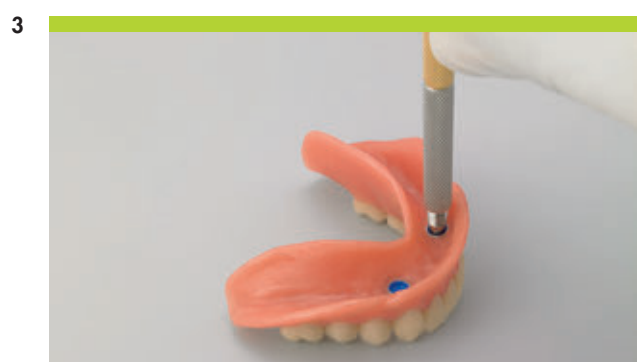

Step 3 – Inserting the replacement male

- Insert the replacement male with the core tool (see chapter 6.10.4).



Step 4 – Inserting the finished denture

- Insert the finished denture and check the occlusion.

6.10.3 LOCATOR® Abutment – Prosthetic procedure (chairside)

For an already existing and well-functioning overdenture, the LOCATOR® system can be used in a chairside procedure.

1



Step 1 – Selecting the abutment height

- Make sure the top of the implant is not covered by the gingiva.
- Select the height of the LOCATOR® abutment by determining the height of the gingiva at its highest point. Example: Pick the LOCATOR® abutment height 2 mm if the gingival height is 2 mm. The abutment is designed in a way that the top margin of the abutment will be 1 mm above the mucosa.

Note

Prosthesis insertion is easier for the patient if the LOCATOR® abutments are on the same horizontal level.

2

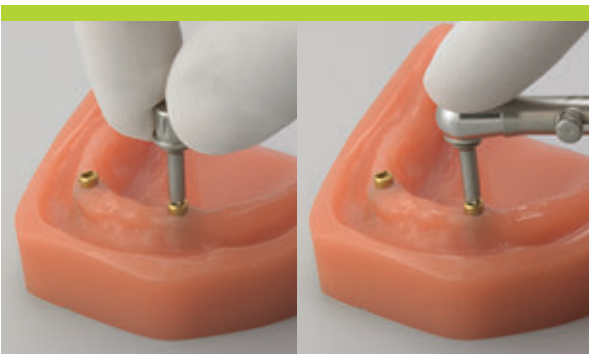

Step 2 – Inserting the abutment

- Screw the abutment into the implant by hand using the LOCATOR® driver.
- Tighten the abutment to 35 Ncm using the ratchet along with the torque control device (for instructions see chapter 7.5) and the LOCATOR® driver attached (see chapter 6.10.4).

3



Step 3 – Placing the block-out spacer

- Place a white block-out spacer ring on the abutments. The spacer is used to block out the area surrounding the abutment.

4



Step 4 – Placing the denture caps

- Place the denture caps with the black processing males onto the LOCATOR® abutments.

5



Step 5 – Hollowing out the denture base

- Hollow out the existing denture base in the areas of the LOCATOR® denture caps.

Note

Ensure that the denture caps fixed on the abutments do not touch the prosthesis.

Step 6 – Filling the connecting holes

- Fill the connecting holes with prosthetic resin from lingual and anchor the caps in the denture (lightcure or selfcuring resin).
- Remove any excess resin after curing and polish the denture.

Note

If the white LOCATOR® block-out spacer does not completely fill the space between the gingiva and the denture caps, any remaining undercuts must be blocked out to prevent resin flowing under the caps. This can be accomplished by stacking two or more LOCATOR® block-out spacers.

Once the resin has cured, remove the denture from the mouth and discard the white LOCATOR® block-out spacers.

7



Step 7 – Selecting the replacement males

- Implant divergence up to 10° for a single implant:

Color	Retention
● blue	0.68 kg
● pink	1.36 kg
● clear	2.27 kg

- Implant divergence between 10° and 20° for a single implant:

Color	Retention
● gray	0.0 kg
● red	0.45 kg
● orange	0.91 kg
● green	1.82 kg

Note

Always start with the lowest retention replacement males.

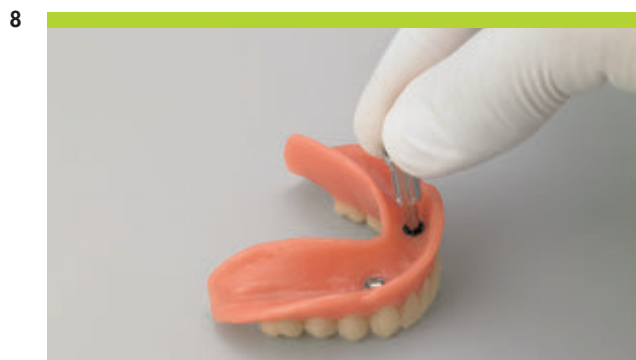

Step 8 – Removing the processing males

- To place the replacement males in the denture housing, remove the black processing males from the housing (see section 3 in chapter 6.10.4).

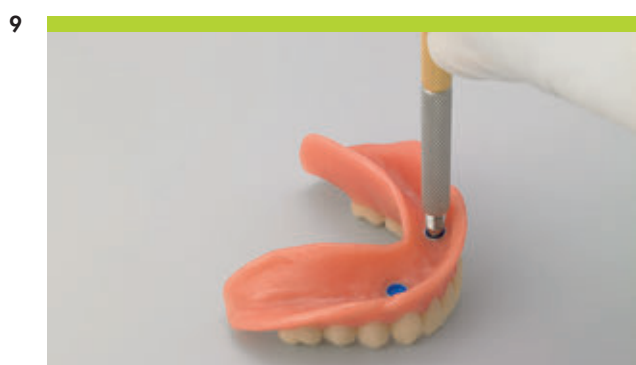

Step 9 – Inserting the replacement male

- Insert the replacement male with the core tool (see chapter 6.10.4).



Step 10 – Inserting the finished denture

- Insert the finished denture and check the occlusion.

6.10.4 LOCATOR® Abutment – Further references

1. Using the LOCATOR® core tool

The LOCATOR® core tool is a three-piece multifunction instrument.

The tip is used for removing replacement males from the denture caps. To do this, unscrew the tip with two full turns. A gap is visible between the tip and the middle section.

In a straight line, guide the tip into the denture cap with a replacement male. The sharp edges of the tip hold the replacement male while it is being removed. Draw the instrument out of the denture cap in a straight line.

To remove the replacement male from the instrument, screw the tip clockwise completely onto the middle section. This activates the loosening pin inside the tip, which releases the replacement male.

The LOCATOR® abutment holder sleeve makes it easier to deliver a LOCATOR® abutment, and it retains the abutment while threading it into the implant. The LOCATOR® abutment holder sleeve can be autoclaved.

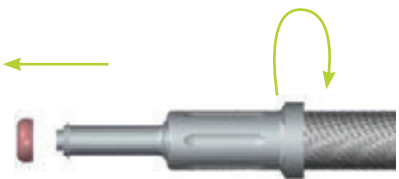

The middle section of the LOCATOR® core tool is used for inserting replacement males into the denture caps. To do this, unscrew the tip. Press the exposed end of the replacement male into the denture cap. You hear a click when the replacement male is fixed firmly in the cap.



The end (gold-colored) of the LOCATOR® core tool is used by the dental technician for screwing and unscrewing the LOCATOR® abutments to and from the analogs.



2. Determining the implant divergences

Snap the LOCATOR® parallel posts onto the LOCATOR® abutments. Use the LOCATOR® angle measurement guide to determine the angulation of the LOCATOR® abutments in relation to each other. Hold the angle measurement guide behind the placed parallel posts and read off the angle for each abutment.

Note

Choose the appropriate LOCATOR® replacement males according to the angulation measured for each abutment.

Tie dental floss through the lateral holes of the angle measurement guide to prevent aspiration.

3. Using the black processing male

Both the LOCATOR® female analog and the LOCATOR® denture cap are supplied with a preassembled black processing male. The black processing male functions as a space keeper for the various LOCATOR® replacement males. For the relining of a LOCATOR-anchored over-denture, the LOCATOR® replacement males must be removed from the denture caps and exchanged with black processing males. The black processing males keep the denture in a stable vertical position during the relining procedure. When the relining of the denture is finished, the black processing males are exchanged with the corresponding new LOCATOR® replacement males.



4. Important cleaning instructions

The proper cleaning of the LOCATOR®-borne denture and the LOCATOR® abutments is a prerequisite to ensure the long-term performance of both the abutments and the nylon processing inserts. An accumulation of plaque on the abutment that imbeds into the nylon processing insert can abrade, over time, the titanium abutment to a smaller diameter and thus cause it to lose retention. According to the specific situation, the patient might be put on shorter recall appointments to monitor the proper cleaning of the denture and the abutments.

7. AIDS AND INSTRUMENTS

7.1 SCS SCREWDRIVER

The SCS* screwdriver is used for the fixation of the prosthetic parts and healing components. The star shape of the screwdriver tip connects to the top of the healing components and abutment screw heads for safe pick-up and handling.

*SCS = **S**crew **C**arrying **S**ystem

SCS screwdriver for manual use

Article: extra short, short, long

Lengths: 15 mm, 21 mm, 27 mm

Art. Nos.: 046.400, 046.401, 046.402

Material: Stainless steel



7.2 POLISHING AID

The polishing aid is used during polishing and other lab procedures to protect the abutment's prosthetic connection and to establish a convenient fixation extension.

Art. Nos.: 025.2920, 025.4920

Material: Stainless steel



7.3 RATCHET AND TORQUE CONTROL DEVICE

The ratchet (Art. No. 046.119) is a two-part lever arm instrument with a rotary knob for changing the direction of force. It is supplied with a service instrument (Art. No. 046.108), which is used to loosen the headed screw. After loosening, the ratchet bolt can be removed from the body of the ratchet. The ratchet gap must be disassembled for cleaning and sterilization.

To apply a certain torque when tightening an abutment screw, use the ratchet together with the torque control device (Art. No. 046.049) and the holding key (Art. No. 046.064).

Ratchet

The ratchet is used in combination with the torque control device to torque in all Straumann abutments and screws (it is the same ratchet used for placing Straumann implants manually).

Note

The ratchet and service instrument are packaged together.

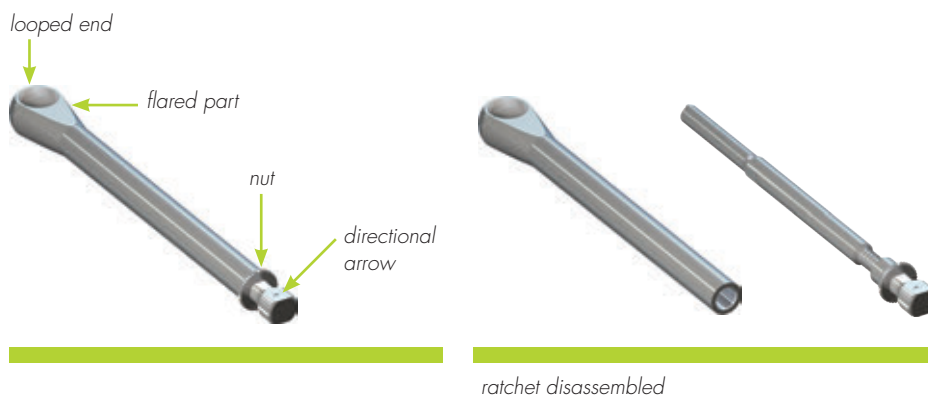

Torque control device

Connected to the ratchet, the torque control device is used to measure the value of Ncm (Newton centimeter) applied when inserting Straumann abutments and screws.



Service Instrument

The Service Instrument is used to assemble and disassemble the ratchet.



Holding key

The forked end of the holding key can be used to assemble and disassemble the ratchet. The pin can be used to stabilize drivers when abutments and screws are placed (also used for implant placement).

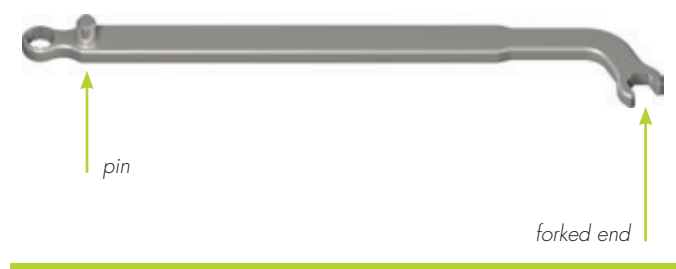

7.4 ASSEMBLING THE RATCHET AND THE TORQUE CONTROL DEVICE



Step 1 – Loosening

- Loosen the ratchet nut with the service instrument or the holding key.

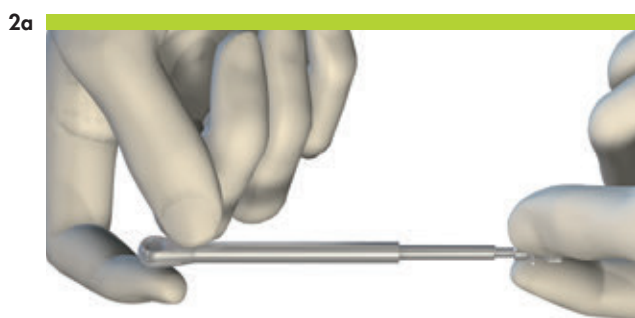

Step 2 – Removing

- Unscrew and remove the internal bolt from the ratchet body.



3a



3b



Step 3a – Insertion

- Insert the ratchet body into the torque control device (flared part of the ratchet must be flush with fluted end of torque control device).

Step 3b – Insertion

- Insert the internal bolt into the opposite end of the torque control device. Tighten it firmly by hand.

4a

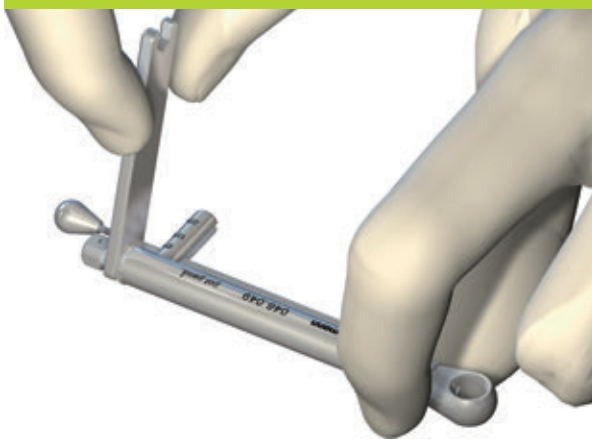

Step 4 – Tightening

- Tighten the nut of the ratchet with the service instrument or the holding key. Do not overtighten.

4b



- The ratchet and torque control device are now assembled and ready for use.

7.5 TIGHTENING AN ABUTMENT TO 35 Ncm

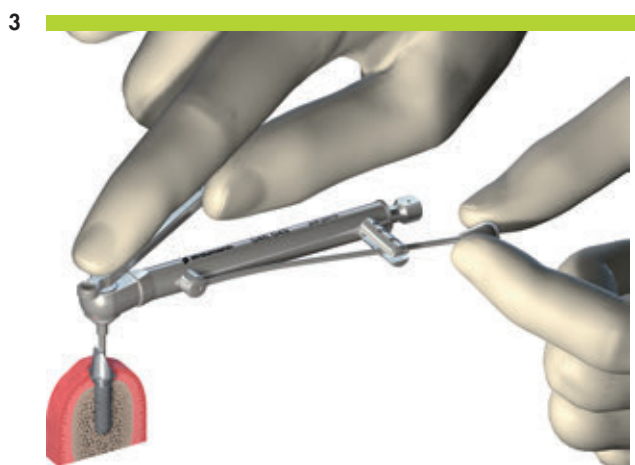
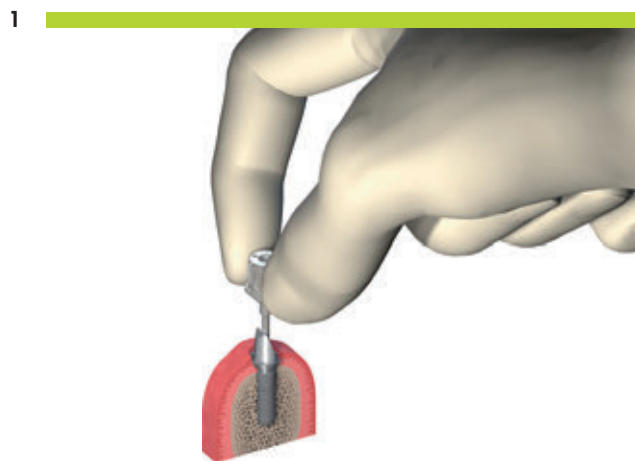

Step 1 – Insertion and tightening

- Insert the abutment into the implant.
- Tighten the abutment screw by hand using the SCS screwdriver.

Step 2 – Placing the ratchet

- Place the looped end of the assembled ratchet with the torque control device over the driver handle. The directional arrow must be pointing in the clockwise direction (towards the torque bar with tear drop). If not, pull the arrow out, flip it over, and let it snap in.

Step 3 – Stabilizing the ratchet

- For stabilization, put the pin end of the holding key into the coronal hole on the driver handle.

4



Step 4 – Positioning of appropriate Ncm mark

- Use one hand to hold the holding key and use the other hand to hold the torque bar. Grasp only the tear drop and move the torque bar to the 35 Ncm mark.

Step 5 – Removing the ratchet

- After reaching the 35 Ncm mark, return the torque bar to its starting position.
- Lift and remove the holding key, the ratchet with torque control device and the driver.

Note

Proper care and maintenance are important to ensure correct function of the ratchet and torque control device. Always clean and sterilize disassembled.

For detailed instructions on how to care for these instruments, please refer to their package inserts.

Recommended tightening torques

Hand-tight	15 Ncm	15–35 Ncm	35 Ncm
Closure screws Healing abutments	Temporary copings Copings	Temporary abutments	Final abutments

8. ABOUT STERILIZATION

Straumann abutments and components are not sterile when delivered. Use the following procedure for sterilization prior to use.

Material	Sterilizing method	Sterilizing Parameters
Ti, Ti alloy	Autoclave, moist heat	134 °C (273 °F) for 5 min
PEEK, PEEK with Ti/Ti alloy inlay		
POM		
Metal alloy Ceramicor® Composition in weight %: Au 60%, Pd 20%, Pt 19%, Ir 1%		
ZrO ₂ (CARES® Abutments and IPS e.max® Abutments)	Dry heat	160 °C (320 °F) for 4 h
ZrO ₂ (zerion®)	Autoclave, moist heat	134 °C (273 °F) for 5 min
PMMA with TAN inlay	Autoclave, moist heat	121 °C (250 °F) for 20 min

Note

Use devices directly after sterilization. Do not store sterilized devices.
Consult the brochure *Guideline for Cleaning, Disinfection and Sterilization – Straumann® Implant-borne prosthetic components, 152.802*.

To prevent tension cracks in temporary copings made from PMMA for solid and cementable abutments, do not use the following: alcohol, UV radiation, sterilization, immersion in liquid for more than one hour or temperatures over 60 °C (140 °F).

9. IMPORTANT GUIDELINES

Please note

Practitioners must have appropriate knowledge and instruction in the handling of the Straumann CAD/CAM products or other Straumann products ("Straumann Products") for using the Straumann Products safely and properly in accordance with the instructions for use.

The Straumann Product must be used in accordance with the instructions for use provided by the manufacturer. It is the practitioner's responsibility to use the device in accordance with these instructions for use and to determine, if the device fits to the individual patient situation.

The Straumann Products are part of an overall concept and must be used only in conjunction with the corresponding original components and instruments distributed by Institut Straumann AG, its ultimate parent company and all affiliates or subsidiaries of such parent company ("Straumann"), except if stated otherwise in this document or in the instructions for use for the respective Straumann Product. If use of products made by third parties is not recommended by Straumann in this document or in the respective instructions for use, any such use will void any warranty or other obligation, express or implied, of Straumann.

Availability

Some of the Straumann Products listed in this document may not be available in all countries.

Caution

In addition to the caution notes in this document, our products must be secured against aspiration when used intraorally.

Validity

Upon publication of this document, all previous versions are superseded.

Documentation

For detailed instructions on the Straumann Products contact your Straumann representative.

Copyright and trademarks

Straumann® documents may not be reprinted or published, in whole or in part, without the written authorization of Straumann. Straumann® and/or other trademarks and logos from Straumann® mentioned herein are the trademarks or registered trademarks of Straumann Holding AG and/or its affiliates.

Explanation of the symbols on labels and instruction leaflets



Batch code



Catalogue number



Sterilized using irradiation



Lower limit of temperature



Upper limit of temperature

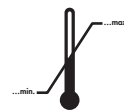

Temperature limitation

Rx only

Caution: U.S. federal law restricts this device to sale by or on the order of a dental professional.



Do not re-use



Non-sterile



Caution, consult accompanying documents



Use by



Keep away from sunlight



Straumann Products with the CE mark fulfill the requirements of the Medical Devices Directive 93/42 EEC



Consult instructions for use

www.straumann.com

International Headquarters

Institut Straumann AG
Peter Merian-Weg 12
CH-4002 Basel, Switzerland
Phone +41 (0)61 965 11 11
Fax +41 (0)61 965 11 01

Ceramicor® is a registered trademark of Cendres + Métaux SA, Switzerland. IPS e.max®, IPS e.max® Ceram, IPS e.max® ZirPress, IPS e.max® Ceram Zirliner, IPS e.max® Ceram Liner are registered trademarks of Ivoclar Vivadent AG, Liechtenstein. LOCATOR® is a registered trademark of Zest IP Holdings LLC, USA. Dolder® is a registered trademark from Prof. Eugen Dolder, exclusively licensed to Cendres + Métaux Holding SA, Switzerland. Ackermann® is a registered trademark licensed to Cendres + Métaux Holding SA, Switzerland. MP-Clip® is a registered trademark licensed to Cendres + Métaux Holding SA, Switzerland. VITA CAD-Temp® is a registered trademark of VITA Zahnfabrik H.Router GmbH & Co. KG. Elitor®/Pekton® is a registered trademark of Cendres + Métaux SA. Createch Medical is a trademark registered by Createch Medical, SL.

© Institut Straumann AG, 2015. All rights reserved.

Straumann® and/or other trademarks and logos from Straumann® mentioned herein are the trademarks or registered trademarks of Straumann Holding AG and/or its affiliates.